



INSTALLATION & OWNER'S MANUAL

Centralized Controller

MODEL: CRF-30-CM

Thank you for purchasing our product.
Before using your unit, please read this manual carefully and keep for future reference.

CONTENT

| | |
|--|-----------|
| 1 Installation part..... | 1 |
| 1.1 Packing list and installation components..... | 2 |
| 1.2 Installation instructions..... | 3 |
| 1.3 Installation methods..... | 3 |
| 1.4 Wiring methods..... | 5 |
| 1.5 Safety precautions..... | 6 |
| 1.6 System wiring instruction..... | 7 |
| 2 Operation part..... | 8 |
| 2.1 Function instructions..... | 9 |
| 2.2 Operation conditions..... | 9 |
| 2.3 Key words..... | 10 |
| 2.3.1 Status indication..... | 10 |
| 2.3.2 Power on or reset..... | 10 |
| 2.3.3 Emergency stop and forced on..... | 10 |
| 2.3.4 Various locking..... | 11 |
| 2.3.5 ON and OFF | 12 |
| 2.4 Operation instructions..... | 14 |
| 2.4.1 Keys instructions..... | 15 |
| 2.4.2 LCD instructions..... | 19 |
| 2.4.3 Other instructions..... | 22 |
| 2.4.4 Error code table..... | 24 |
| 2.5 Technical index and requirements..... | 25 |



INSTALLATION PART

1.1 Packing list and installation components

1. Please check the packing list of the centralized controller, whether the components are complete.

| No. | Name | Quantity | Remarks |
|-----|------------------------------------|----------|-----------------------|
| 1 | Centralized controller | 1 | _____ |
| 2 | Cross-recessed head tapping screws | 6 | GB845/ST3.9*25-C-H(S) |
| 3 | Fastening plastic expansion pipe | 6 | Φ6*30 |
| 4 | Installation & Operation Manual | 1 | _____ |
| 5 | Matching resistance | 4 | 120 Ω |

2. Installation assemblies prepared on the site

| No. | Name | Quantity (install into wall) | Selected model | Remarks |
|-----|--|---------------------------------|------------------------------------|--|
| 1 | 3-core control shielded cable | 2 PCS | RVVP-300/300 3×0.75mm ² | One for communicating with the air conditioner; the other for communicating with the computer. |
| 2 | 3-core cable | 1 PCS | RVV-300/500 3×1.5mm ² | For power supply of the centralized controller |
| 3 | Switch box | 1 PCS | _____ | _____ |
| 4 | Wire pipe(jack casing pipe, captive nut) | 2/3 PCS | _____ | _____ |
| 5 | Tighten strip | Several pieces | _____ | For binding cables(as the case maybe) |

1.2 Installation instructions

Installation instructions

- 1) Connect 220VAC power to the L、N terminals of the centralized controller directly.
- 2) Do not lay the signal wire and the power wire of the centralized controller in the same power wire pipe, there should be 300~500mm distance between two pipes.
- 3) The signal wire of centralized controller should not exceed 1200m.
- 4) No intermediate joint is allowed for the shielded cable. If joints are inevitable, crimp it with the terminal block.
- 5) After the centralized controller is connected, do not use megohmmeter to inspect the insulation of the signal cable.
- 6) Wiring mode of the centralized controller and the network interface:

The communication port between the centralized controller and the network interface of the air conditioner is polarity-sensitive. The X, Y and E at both sides should correspond properly. Do not cross-connect the signal wires, the same to the RS485-RS232 of the centralized controller.

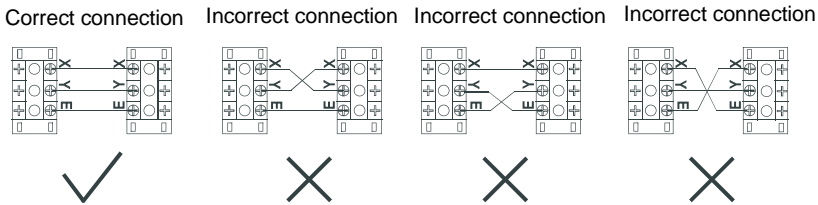

1.3 Installation methods

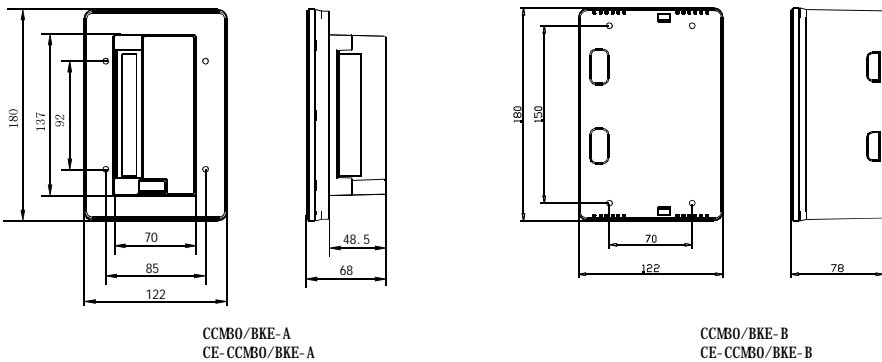

Fig.1.1 Centralized controller size (unit: mm)

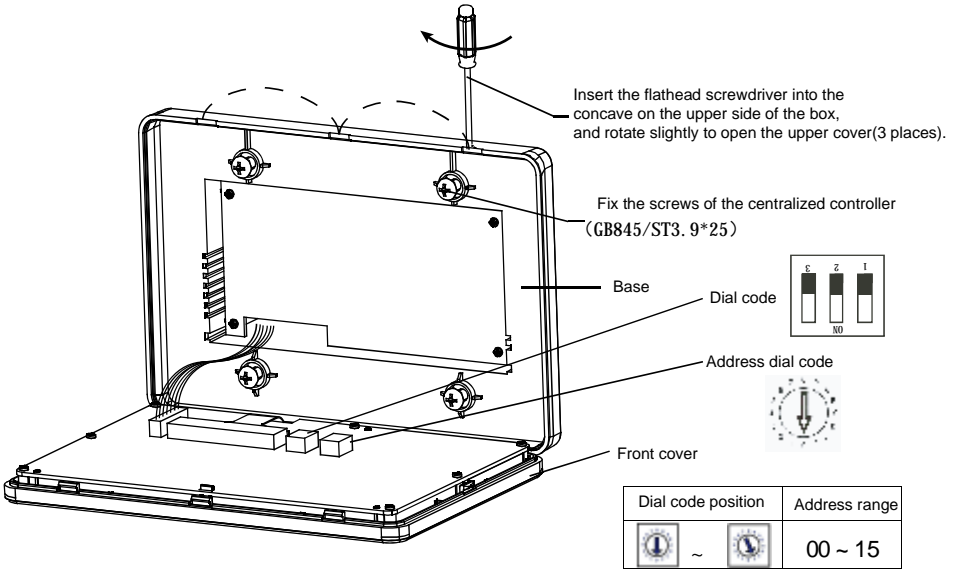

Fig. 1.2 Installation diagram

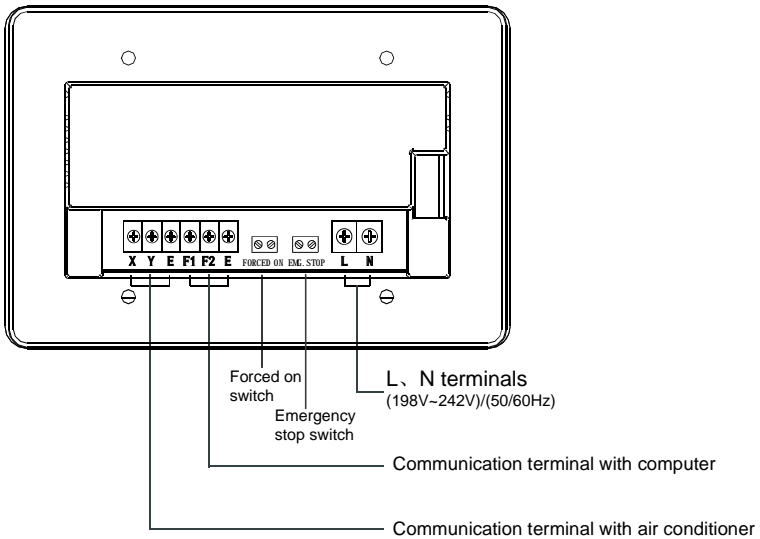

Fig.1.3 Terminal instruction of centralized controller



Note

The RS485-to-RS232 module and the wires in the wiring diagram are used when the network system needs to connect with the computer only. One computer can connect with 16 centralized controllers at most, namely the maximum of indoor units is $16 \times 64 = 1024$, that a network system can connect. The centralized controllers can be distinguished by address code, which setting range is 0 to 15. No duplicate addresses is allowed in a same network.

1.5 Safety precautions

■ Safety precautions

- ! Read the safety precautions carefully before installing the unit.
- ! Stated below are important safety issues that must be obeyed.
- ! The meanings of all parts are as follows:

| | | |
|--|---------|---|
| | Warning | Means improper handling may lead to personal injury or property loss. |
| | Note | Means improper handling may lead to personal death or severe injury. |

- ! Upon completion of the installation, check whether the trial run is normal, and deliver the user's manual to the user.



Warning

Please entrust the distributor or professionals to install the equipment. Installation by unauthorized persons may lead to imperfect installation which may result in electric shock or fire.

Adhere to this installation manual. Improper installation may lead to electric shock or fire.

Reinstallation must be performed by professionals. Improper installation may lead to electric shock or fire.

Do not uninstall the equipment without permission. Unauthorized uninstalling may lead to abnormal operation, heating or fire of the air conditioner.



Note

Do not install the equipment in a place vulnerable to leakage of flammable gases. Once flammable gases are leaked and left around the centralized controller, fire may occur.

The wiring shall adapt to the current of the centralized controller. Otherwise electric leakage or heating may occur and result in fire.

1.6 System wiring instruction.

1) Wiring diagram of building network airconditioning system.

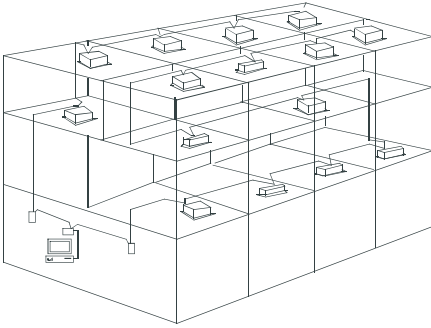

(a)

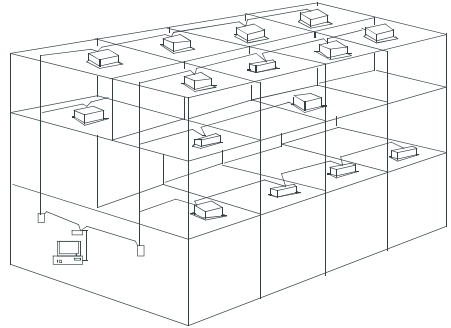

(b)

(a) The wiring system is good for communication, recommended

(b) The wiring system is bad for communication, not recommended

2) System wiring diagram of centralized controller and indoor unit of air conditioner.

Both of the following wiring modes of centralized controller and indoor unit are applicable:
(The number of indoor units connected with each centralized controller is not beyond 64)

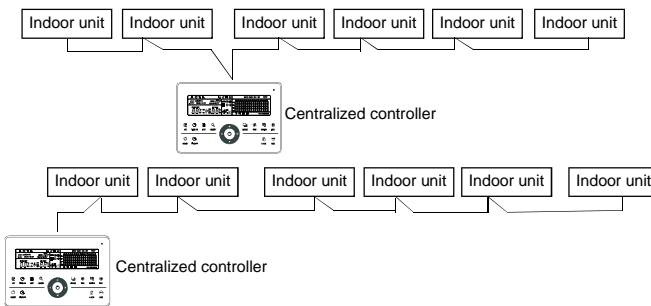

Fig.1.5 Wiring diagram of centralized controller and indoor unit of air conditioner



OPERATION PART

2.1 Function instructions

1. Centralized controller is used for controlling and data querying of air conditioners in the network. Each centralized controller can be connected to maximum 64 indoor units, through 485 communication can to form an air conditioner LAN and realize the centralized controlling network in the air conditioner.
2. Centralized controller can connect with computer or gateway, to realize the LAN connection between computer and all the air conditioners , then can use computer to remote control (the computer software must support it). Each local computer or gateway maximally connect 16 centralized controllers.
3. Between centralized controller and air conditioner, computer and centralized controller are applied to the master-slave responding communication method. In the LAN of centralized controller and air conditioner, centralized controller will be the master unit, and the air conditioner will be the slave unit. In the LAN of computer and centralized controller, the computer or gateway will be the master unit, and the centralized controller will be the slave unit.
4. For the new series product, we can connect the indoor CCM controller via XYE port of master outdoor unit of every refrigerant system. Notice that in this case, the outdoor unit must be set to automatic serching address mode. And it will be effective after about 6 minutes.
5. To connect indoor CCM controller via XYE port of indoor unit, this wiring method is suitable for all type of indoor units, not just for new indoor units.
6. When new indoor units and old indoor units mix connect to one refrigerant system, we can just connect the indoor CCM controller via XYE port of indoor units. If we connect the indoor CCM controller via XYE port of master outdoor unit, the CCM controller can not control old indoor units.
7. If one system that connect to indoor CCM controller include 10 HP or above duct indoor unit, we recommend you set the address of every indoor unit manually.

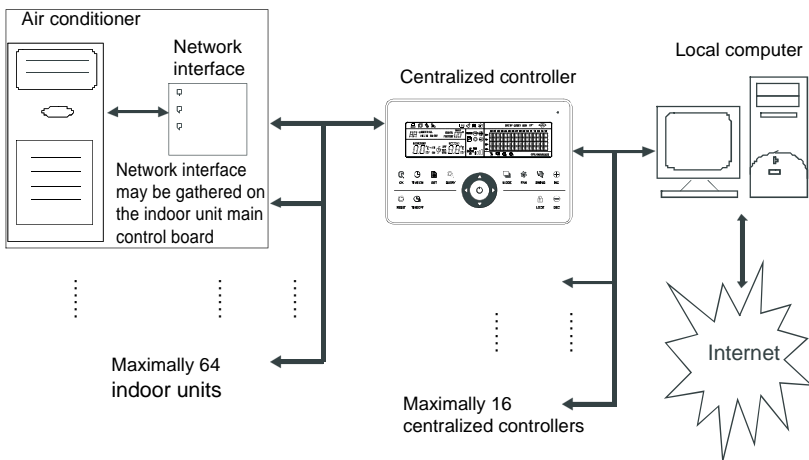

Fig.2.1 Air conditioner network control system structure diagram

2.2 Operation conditions

1. Power and voltage range:
Input voltage: single phase 198V~242V;
AC input power frequency: 50Hz/60Hz;
2. Operating environment temperature: -15°C ~+43°C;
3. Operating environment humidity: RH40%~RH90%.

2.3 Key words

2.3.1 State indication

1. LED for state indication

1) Normal state

① On

The LED will be on when any one of the following occur:

- a) In the centralized controller network, one or more air conditioners are under operating state.
- b) Through the centralized controller's operation, when the centralized controller is sending order to the air conditioners, the LED will be on. When centralized controller finishes sending, the LED will be off.

② Off

The air conditioners in the centralized controller network are all under off status.

2) Abnormal state

If the air conditioners in the centralized controller network are error or the controller network is error, the LED will flash as 2 Hz.

2. Backlight

The backlight will be on by pressing any key except "", when the backlight is off.

The backlight will be on, when centralized controller is operating,

The backlight will be off, if no key is pressed over 30s.

3. Buzzer

When the backlight is on and the centralized controller keys are un-lock, any key (except for the ) is pressed, the centralized controller will carry on relative function, the buzzer will buzz once. If this key has long press function, the centralized controller will carry on the relative function, but the buzzer will buzz once only.

When the backlight is off, any key (except for  key) is pressed, only the backlight is lighted on, the centralized controller will not operate the key, and the buzzer will not buzz.

2.3.2 Power on or reset

When the centralized controller is powered on or reset through the key  :

The buzzer long buzz for 2 seconds: all display segments of LCD are luminous for 2 seconds and then goes off;

1 second later, the system enters the normal display status. The centralized controller is in the main page display status and displays the first page, and searches the in-service air conditioners in the network.

Once the search is finished, the centralized controller enters the mode setting page, and sets the first in-service air conditioner by default.

2.3.3 Emergency stop and forced on

When the emergent stop switch of the centralized controller is connected, all the air conditioners in the centralized controller network will be shut down compulsorily, and the LED flashes as 0.5Hz. The centralized controller and computer and all functional modules are disabled from startup and shutdown until the emergent stop switch is break. When the forced on switch of the centralized controller is connected, all air conditioners in the network of the centralized controller will start up compulsorily. By default, they will run in the cooling mood. The startup and shutdown operations of the centralized controller and computer and all functional modules will be disabled (only the command of startup is sent to the air conditioner, without affecting operation of the remote controller after startup) until the forced on switch is break.

If the foregoing two switches are connected concurrently, the emergent stop switch shall have preference.

2.3.4 Various locking

1. Centralized controller locking

The centralized controller locking state will be recorded when powered off. It won't dismiss when re-power on until receiving the unlocking order.

1) Effect

① When the centralized controller is under locking state, it can not change the air conditioner's operating state through the centralized controller (such as ON/OFF the unit, setting mode, change the setting temperature, change the fan speed, unlock the exiting locking state etc), but it can do the query operation, until unlocking and then recover to normal.

② When the centralized controller is under locking state, all the air conditioners in the centralized controller network will be remote controller locked.

2) Operation

① Locking



The centralized controller can be locked by the computer only.

② Unlocking

a) When the centralized controller and computer communicate normally

The centralized controller can be unlocked by the computer only. When the centralized controller is unlocked, the controller will send order to unlock the remote controller locking of all the air conditioners.

b) When the centralized controller and computer communicate abnormally

When the centralized controller is locking, the centralized controller can be unlocked by the way that press "" key and hold on, then press "" (It should operate within one minute after centralized controller is re-powered on or the "" is pressed).

The remote controller locking of the air conditioner is remained.

2. Remote controller locking

1) Effect

① When the air conditioner is under remote controller locking state, it will not receive the remote signals from remote controller or wire controller, until unlocking.

② The air conditioner can be operated by the centralized controller.

2) Operation

① Can lock or unlock through the computer.

② Can operate by centralized controller.

In the centralized controller setting interface, press "" to lock or unlock.

If the current state is remote controller locking, press the key to unlock.

If there's no remote controller locking, press the key to lock.

3. Mode locking

1) Effect

Under mode locking state, through centralized controller to operate the air conditioner, only can choose the mode which has not conflict with locking mode.



2) Operation

Can set the heating mode locking or cooling mode locking.

Under mode locking state, if set the new mode locking, it must be unlocking first, then can operate the new mode locking.

① Can lock or unlock through the computer.

② Can operate by centralized controller.

In the centralized controller setting interface, choose all the air conditioners of the centralized controller network as the object, press “” and hold on, then press “” to do the mode locking or unlocking.

If the current state is mode locking, press the key to unlock.

If there's no mode locking, press the key to lock.

4. Centralized controller key locking and unlocking

1) Effect



When centralized controller keys are locked, keys operation is invalid except “” key and unlock keys.

2) Operation

1. Press “” key and hold on, then press “” key, the keys of centralized controller will be locked or unlocked.



If the current state is key locking, press the key to unlock.

If no centralized controller key locking, press the key to lock.

2. When the backlight turns off, the keys will be locked automatically. Press any key to light the backlight first. Secondly, press “” key and hold on, press “” key to unlock keys. Then operation to the controller is enabled.

The backlight will turn off and the keys will be locked automatically if there's no operation within 30 seconds.





2.3.5 ON and OFF operation





Use the “” key or “” key to do the ON and OFF operation for the air conditioners in the centralized controller network.

The ON mode will accord to the system mode locking or other limit conditions for judging, if there is conflict, it will auto adjust to the next mode without conflict; if all the modes have conflict, then it can not operate the unit.

1. Use “” key to ON and OFF the unit

Can operate a single air conditioner or all the air conditioners in the centralized controller network.

1) Choose the object. Press “” key to choose a single air conditioner or all the air conditioners in the centralized controller network. If choose a single air conditioner, then use “”, “”, “”, and “” to choose the air conditioner.

2) Use “”, “”, “”, and “” to set the operating mode and operating parameters, such as fan speed, setting temperature etc.

3) Use “” key, centralized controller send the relative order to the operating object.

After setting the operating parameter for the air conditioner, if not press the “” key the setting parameter will not be sent to the air conditioner, and the current operation of the air conditioner is not affected (except locking operation).

2. Use “” key to ON and OFF the unit

Only can operate all the air conditioners in the centralized controller network, not for single air conditioner.

“” key long press: press this key for over 2 seconds then loose.

“” key short press: press this key and then loose within 2 seconds.

According to different states and operation ways of air conditions in the current centralized, there are following situations:

1) One or more air conditioners under ON state (include timing process of timing ON and OFF)

“” key only has short press function.

Only send the OFF order to the air conditioners with ON state, not for OFF state units.

The memory function is activated, the current state of all air conditioners is memorized.

2) All the air conditioners in the centralized controller network are OFF states

① “” key short press

The centralized controller reads the memory contents, and sends relative order to all air conditioners.

② “” key long press

a) If current page is setting parameters, and the setting mode is not OFF, the centralized controller will send orders to all air conditioners according to parameters, such as setting mode, fan speed, setting temperature, etc.

b) If the current is under setting interface but the setting mode is OFF state or under other interfaces, the centralized controller will send the default ON order to all air conditioners. The default ON order is : cooling mode, high fan speed, setting temperature is 24°C or 76°F, operate the swinging function.

2.4 Instruction of electric control function

Keys of centralized controller

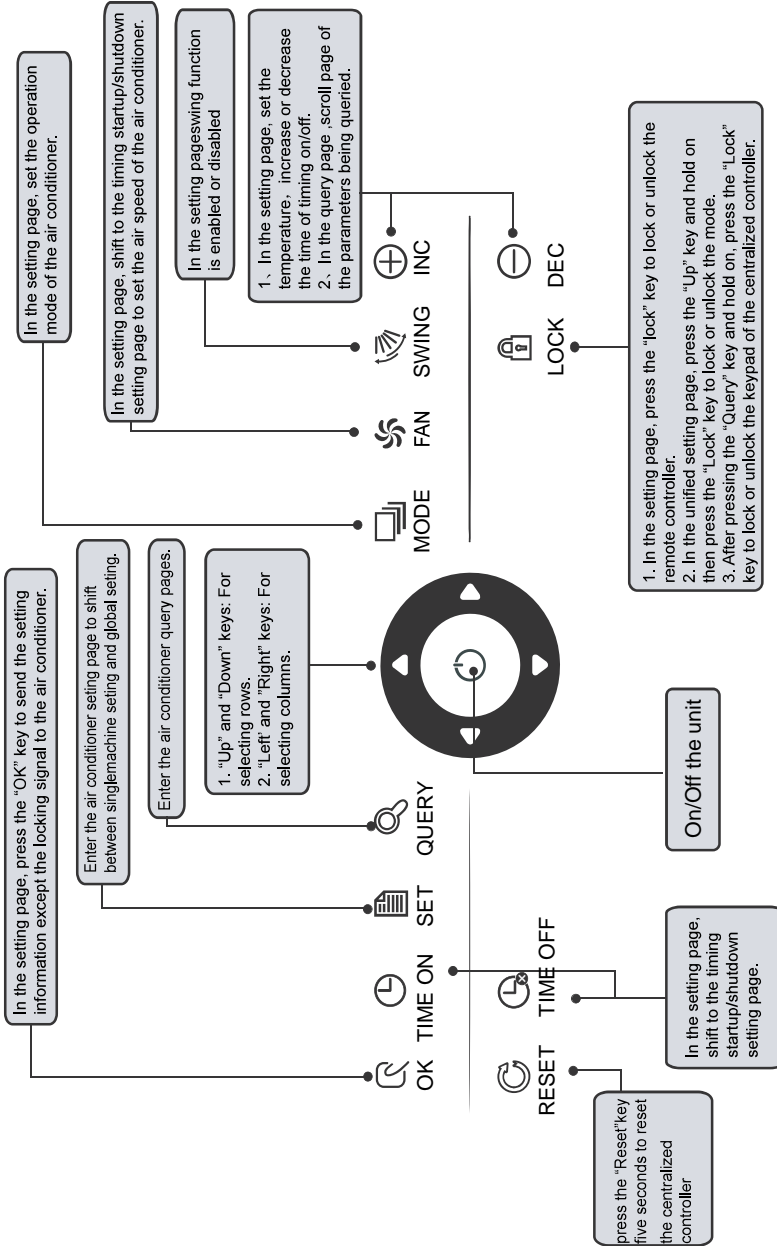

Fig.2.2 Keys of centralized

2.4.1 Key operation instruction

1. Query key “”

Any time when you press the key, the selected operation mode is to query the operation status of the air conditioner.

By default, the first in-service air conditioner will be queried.

2. Set key “”

In other display mode, press the key “” to enter the setting mode.

By default, it is single setting, and the first in-service air conditioner is displayed.

In setting operation mode, press the key “” again, and the operation will be performed for all air conditioners in the network. Press the key repeatedly to shift between single setting and global setting.

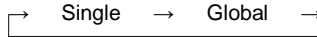

3. Mode key “”

In setting operation mode, Press this key to set the operation.

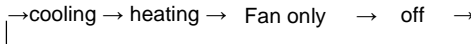

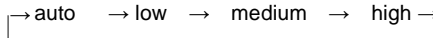

4. Fan key “”

In setting operation mode, press this key to set the fan of the indoor unit of the air conditioner to run in the automatic, high, medium or low level of air.





5. Time on key “”

In setting operation mode, press this key “” to set the timing startup of air conditioner;

Press the key “” again to exit the timing setting, and restore the normal temperature regulation operation mode.

6. Time off key “”

In setting operation mode, press this key “” to set the timing shutdown of air conditioner,

Press the key “” again to exit the timing setting, and restore the normal temperature regulation operation mode.

7. Swing key “”

In setting operation mode, press this key “” to enable or disable the swing function.

If all currently selected air conditioners have no swing function, no effect will result after pressing the key.

8. Leftward key “”

In the query mode, if this key is pressed, the operation status data of the previous air conditioner will be displayed. If it is currently on the first machine, the data of the last machine will be displayed, when the key is pressed. If you hold down this key, the address will decrease one by one.

In the setting mode, if it is in single operation mode, the air conditioner of the previous in-service address number will be selected, when this key is pressed, If it is in the global operation mode, no effect will result when this key is pressed.

In the main page, press the key to enter the query mode. By default, it is the first in-service air conditioner.

9. Rightward key “ ”

In the query mode, when the key is pressed, the next in-service air conditioner is selected, and its operation status data will be displayed. If it is currently on the last air conditioner, the first one is selected and its data displays, when the key is pressed. If this key is hold down long, the address will increase one by one.



In the setting mode, if it is in the single operation mode, when the key is pressed, the next in-service air conditioner will be selected. If it is in the global operation mode, no effect will result when the key is pressed.

In the main page, press the key to enter the query mode. By default, it is the first in-service air conditioner.

10. Downward key “ ”

In the main page, press this key “ ” to enter the query mode. By default, it is the first in-service air conditioner.

In any other time, press this key “ ” will select the next row corresponding position air conditioner.

In the setting mode, if the global operation mode is selected, this key “ ” is invalid. If it is on the last row, press this key “ ” again to shift to the first row air conditioner. If this key “ ” is hold down long, the row will increase one by one.

11. Upward key “ ”

In the main page, press this key “ ” to enter the query mode. By default, it is the first in-service air conditioner.

In any other time, press this key “ ” will select the previous corresponding position air conditioner.

In the setting mode, if selected all the air conditioners to operate, this key “ ” is invalid.

If it is on the first row, press this key “ ” again, and shift to the last row corresponding air conditioner.

If you hold down this key “ ”, the row will decrease one by one.

12. Add key “ ”

1) Query mode

Press this key “ ”, display the data of the last page.

If it is now in the last page, press the key “ ” again and the first page will be displayed.

2) Setting operation mode

① Temperature adjusting method

Press this key “ ”, the setting temperature will increase one degree.

If you hold down the key “ ”, the setting temperature will increase one by one.

When reached the highest allowed set temperature, it can not increase.

② Timing on or timing off setting method

Press this key “ ”, it will select the next setting time.

If you hold down the key “ ”, the next data will be selected one by one.

When reached the max. allowed setting time, it can not increase.

The timing setting change mode is as follow:

0.0 → 0.5 → 1.0 → 1.5 → 2.0 → 2.5 → 3.0 → 3.5 → 4.0 → 4.5 → 5.0 → 5.5
↓
13 ← 12 ← 11 ← 10 ← 9.5 ← 9.0 ← 8.5 ← 8.0 ← 7.5 ← 7.0 ← 6.5 ← 6.0
↓
14 → 15 → 16 → 17 → 18 → 19 → 20 → 21 → 22 → 23 → 24

13. Reduce key “ ”

1) Query mode

Press this “ ” key, display the data of the previous page.

If it is now in the first page, press the key “ ” again and the last page will be displayed.

2) Setting operation mode

① Temperature adjusting method

Press this key “ ”, the setting temperature will decrease one degree.

If you hold down the key “ ”, the setting temperature will decrease one by one.

When reached the lowest allowed set temperature, it can not decrease.

② Timing on or timing off setting method

Press this key “ ”, it will select the next setting time.

If you hold down the key “ ”, the next data will be selected one by one.

When reached the min allowed setting time, it can not decrease.

The timing setting change mode is as follow:

24 → 23 → 22 → 21 → 20 → 19 → 18 → 17 → 16 → 15 → 14 → 13
↓
5.5 ← 6.0 ← 6.5 ← 7.0 ← 7.5 ← 8.0 ← 8.5 ← 9.0 ← 9.5 ← 10 ← 11 ← 12
↓
5.0 → 4.5 → 4.0 → 3.5 → 3.0 → 2.5 → 2.0 → 1.5 → 1.0 → 0.5 → 0.0

14. ON/OFF key “ ”

Any time when you press the key “ ”, the centralized startup/shutdown operation is performed for all current in-service air conditioners in the centralized controller network.

Detailed operation refers to P12.

15. Confirmation key “ ”

In the setting mode, press the key “ ” to send the currently selected mode status and the auxiliary function status to the selected air conditioner.

Detailed operation refers to P12.

16. Reset key “ ”

Any time when the reset key “ ” is pressed, the centralized controller will reset. The result is the same as the result of restoring power-on after power failure.

17. Lock key “ ”

Any time when this key “ ” is pressed, the selected air conditioner can be locked or unlocked.

Detailed operation refers to P11.

Full display of LCD

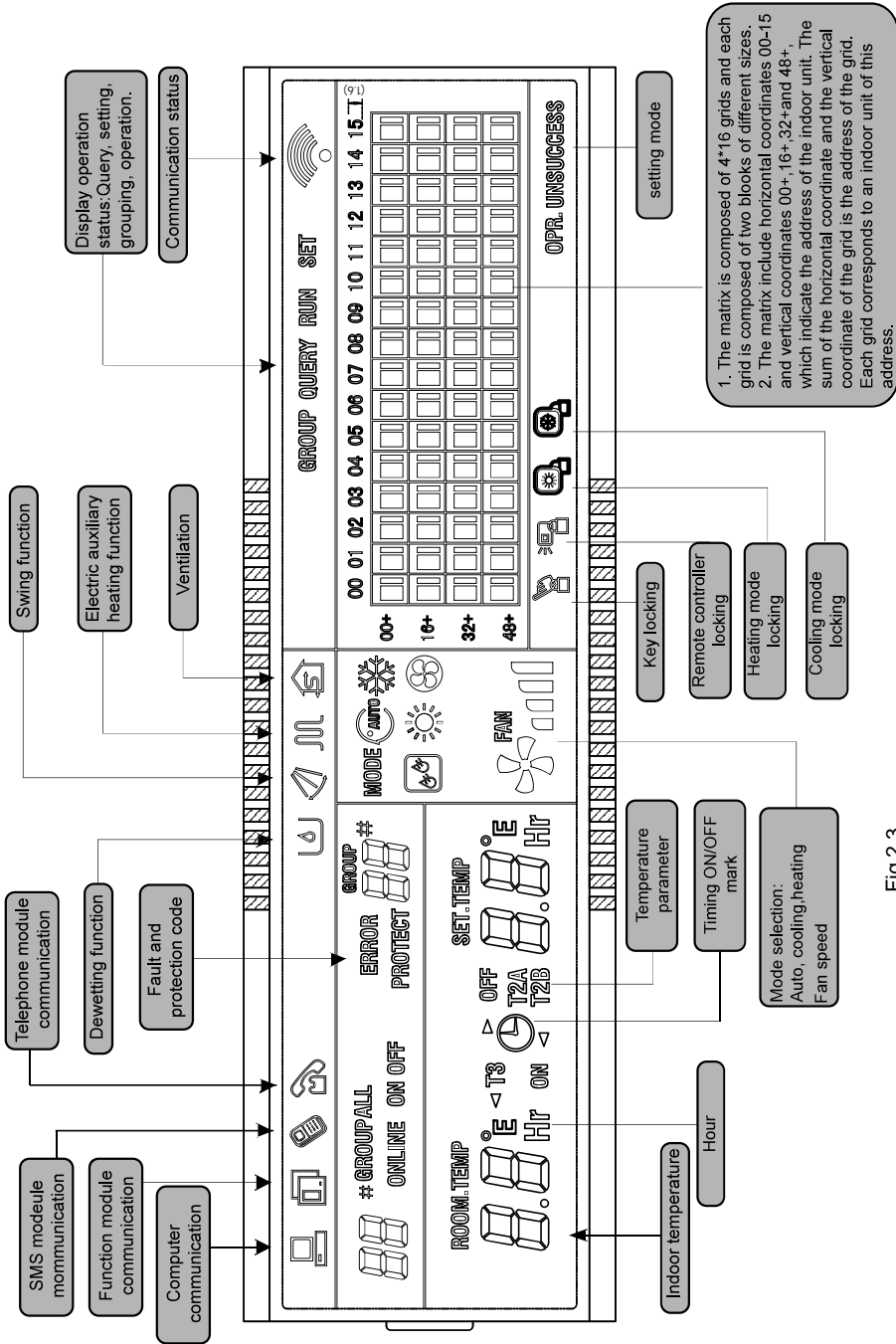



Fig.2.3

2.4.2 LCD instruction

1. General display data



1) General display data is displayed in all display pages.

①The icon  displays when the centralized controller communicates with the computer or gateway normally, otherwise, it doesn't display.

②The icon  displays when the centralized controller communicates with the functional module normally, otherwise, it doesn't display.

③The icon  displays when the centralized controller communicates with the SMS remote control module normally, otherwise, it doesn't display.

④The icon  displays when the centralized controller communicates with the telephone remote control normally, otherwise, it doesn't display.

⑤The icon  displays in the cycle: (blank) → ● →  →  → (blank), when the centralized controller communicates with the network interface normally.

⑥The icon  displays as 0.5Hz when the current state is centralized controller locking. The icon will be displayed constantly when the state is key locking.

⑦The icon  displays when the current state of the selected air conditioner is remote control locking.

The icon will always display if all the air conditioners are remote control locking.

In the global setting page, the icon displays if any air conditioner is remote control locking.

⑧The icon  will be displayed, if the current state is cooling mode locking.

The icon  will be displayed, if the current state is heating mode locking.

2) Display data instruction

①Indoor unit code (address) display: Display range: 00~63; with “#” being luminous concurrently.

②Indoor temperature display: Display range: 00~99°C (or 99°F). “°C” (or “°F”) and “indoor temperature” are displayed concurrently. If the temperature is higher than 99°C (or 99°F), 99°C (or 99°F) is displayed. If the temperature value is invalid, “-” is displayed.

③If timing startup/shutdown is set, the flag  is displayed.

④T3, T2A and T2B display: In the single-machine query page, display can shift among “T3”, “T2A” and “T2B”, and the temperature value is displayed concurrently, with the corresponding “°C” (or “°F”) being luminous.

⑤In case of air conditioner fault or protection, the corresponding fault code or can be displayed.

⑥Liquid crystal matrix display description:

| | 00 | 01 | 02 | 03 | 04 | 05 | 06 | 07 | 08 | 09 | 10 | 11 | 12 | 13 | 14 | 15 |
|-----|----|----|----|----|----|----|----|----|----|----|----|----|----|----|----|----|
| 00+ | | | | | | | | | | | | | | | | |
| 16+ | | | | | | | | | | | | | | | | |
| 32+ | | | | | | | | | | | | | | | | |
| 48+ | | | | | | | | | | | | | | | | |

a. The array of the liquid crystal display is composed of 4X16 grids, and each grid is composed of two blocks of different sizes (as shown in the above figure). The status indication table is as follows:

| Status Object | Constantly on | Slow blink | Fast blink | Not bright |
|-------------------|---------------|------------|------------------------------|----------------|
| Big black block | In-service | Selected | | Out of service |
| Small black block | Power on | | Fault of indoor/outdoor unit | Power off |

b. The array includes horizontal coordinates 00-15 on the up side and vertical coordinates 00+, 16+, 32+ and 48+ on the left side, which indicate the address of the indoor unit. The sum the horizontal coordinate and the vertical coordinate composes the grid the address of the grid. Each grid corresponds to an indoor unit of this address.

2. LCD display description

1) Description of the main page

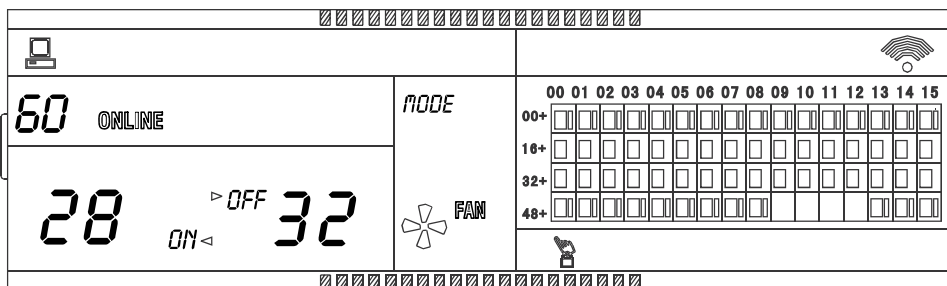

Fig 2.5 The example diagram of the main page

①The LCD displays the main page, 60 air conditioners are in service, which 28 are powered on and 32 off.

②The address of the air conditioners is sum of the coordinates. For example, the address of (48+, 09) is 48+09=57.

③In the array, the big dots from (16+, 00) to (32+, 15) are luminous, and the small dots are not luminous. It indicates the 32 air conditioners with the addresses from 16 to 47 are powered off.

④In the array, the big and small dots from (48+, 09) to (48+, 12) are not luminous. It indicates the four air conditioners with the addresses from 57 to 60 are outside.

⑤All other big and small dots in the array are luminous. It indicates all other air conditioners are in the net powered on.

⑥The centralized controller communicates with the computer normally, when the keypad of the centralized controller is locked.

2) Description of the query page

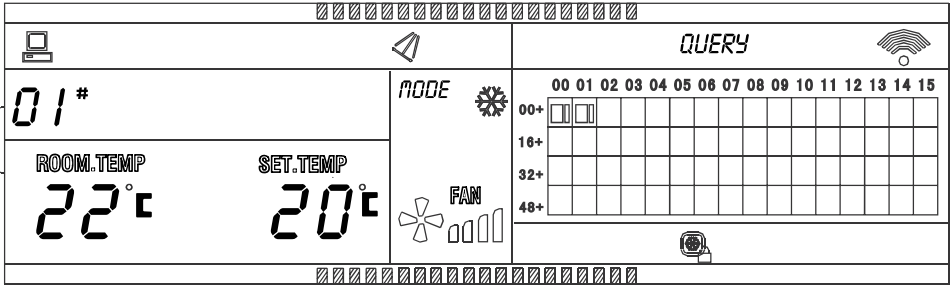

Fig 2.6 The example diagram of the query page

- ①The LCD display shows the query page, and the air conditioner with the address of 01 is being queried.
- ②Mode of the air conditioner with the address 01 is: Cooling, strong air, swing on, indoor temperature 22°C, set temperature 20°C, cooling mode “lock”.
- ③In the array, only the big and small black dots at (00+,00) and (00+,01) are luminous . It indicates the in-service and power-on status of the air conditioners with the addresses of 00 and 01.
- ④The centralized controller communicates with the computer normally.

3) Description of the setting page

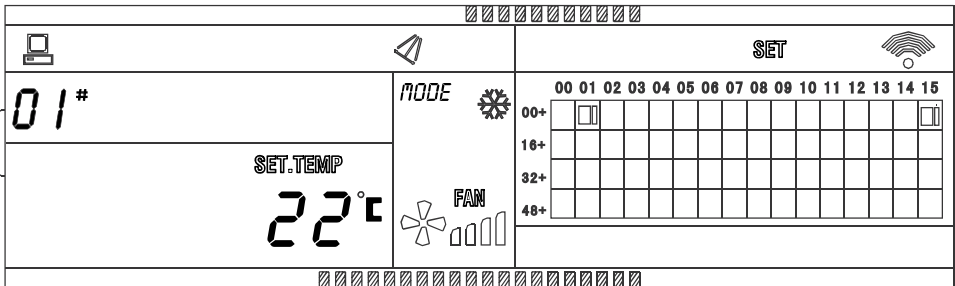

Fig 2.7 The example diagram of setting page

- ①The LCD display shows the setting page, and queries the air conditioner with the address of 01 .
- ②The mode of the air conditioner with the address 01 is: Cooling, strong air, swing on, set temperature 22°C, cooling.
- ③In the array, only the big black dots at (00+,01) to (00+,15) are luminous. It indicates the air conditioners with the addresses 01 and 15 are in service.
- ④The centralized controller communicates with the computer normally.

4) Fault page display description

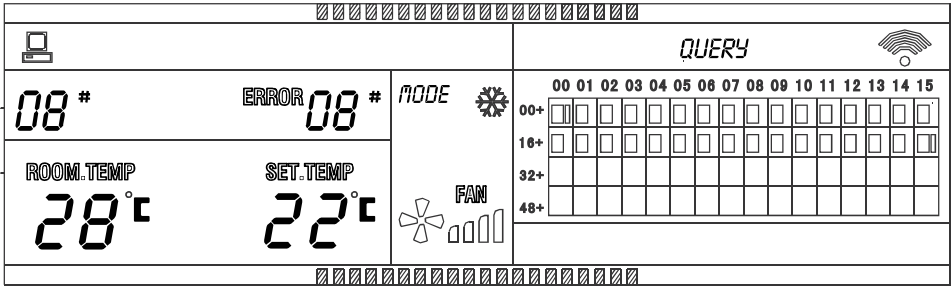

Fig 2.8 The example diagram of fault page

- ① Query the air conditioner with the address of 08 in the query page.
- ② The air conditioner with the address of 08 is faulty, and fault code is 08. The big black dot below (00+,08) blinks.
- ③ In the array, only the big and small black dots at (00+,00) and (16+,15) illuminate. It indicates the in-service status of the air conditioner power on, with the addresses 00 and 31.
- ④ The centralized controller communicates with the computer normally.

2.4.3 Other specifications

1. Dial code operation specification

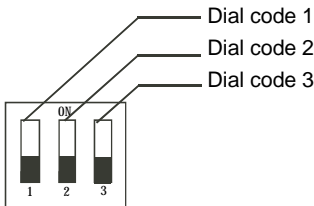

Table 2-1 Dial code definitions

| | ON | OFF |
|-------------|-----------------------|----------------------|
| Dial code 1 | Three-pipe CCM30 | Two-pipe CCM30 |
| Dial code 2 | Fahrenheit | Centigrade |
| Dial code 3 | Has optional function | No optional function |

2. reminding function to clear the filter

- ① When the time of centralized controller powered on add up to the selected parameter time, the centralized controller will remind the user to clear the filter. The reminding dual eight (Fig. 2.9c) displays "FL".
- ② When the centralized controller display FL, it needs to manual operation to clear this reminding. Press "SWING" key and hold on then press "QUERY" key, can clear FL reminding. At the same time, the accumulated time of centralized controller powered on will be cleared.

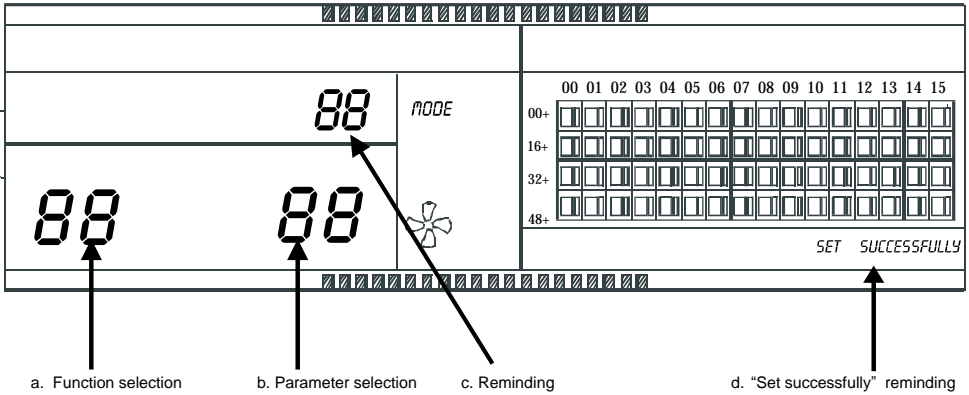









Fig 2.9 Filter net in addition to the dust function involves of show a contents

2) Function setting

① Dial the dial code 3 to "ON", select the "Has optional function" referring to table 2.1 to , and then power on the centralized controller, in 1 minute press "  " key and hold on then press "  " key, enter to optional function setting. Dual eight represented function selection (Fig.2.9 a) will be flashed with 1Hz frequency (default display 00), display the optional function code (see table 2.2). Press "  " and "  " keys to select function, and then press "  " key to enter parameter selection.

②After enter parameter selection, dual eight represented function selection will be lighted on, dual eight represented parameter selection (Fig.2.9 b) will be flashed with 1Hz frequency, display optional parameter code. Through pressing "  " and "  " keys to select the detailed parameter.

③Press "  " to confirm parameter selection(details parameter codes' corresponding time refer to table 2.3).

④After setting successfully, Dual eight represented function selection and dual eight represented function selection will be lighted on, the screen will display "Setting successfully" (Fig. 2.9 d). After 3 seconds will auto exit optional function setting. The screen will back to normal display.

After enter optional function setting, no operations in 5 seconds will auto exit function selection, the setting parameter will not change. Only press "  " key to confirm the parameter then the setting parameter will save.

Table 2-2 The code of selecting the clear filter function

| Function code | Function setting |
|---------------|----------------------------------|
| 00 | Only display, no function |
| 01 | Cleaning filter screen reminding |

Table 2-3 The code of different times of reminding clear filter

| Parameter code | Time (hour) |
|----------------|-------------|
| 00 | 0 |
| 01 | 1250 |
| 02 | 2500 |
| 03 | 5000 |
| 04 | 10000 |

2.4.4 Fault and protection code table

| Fault code | Fault content | Description |
|------------|--|-------------|
| EF | Other faults | |
| EE | Water level detection faults | |
| ED | Reserved | |
| EC | Cleaning fault | |
| EB | Inverter module protection | |
| EA | Over-current of compressor(4 times) | |
| E9 | Fault of communication between main board and display board | |
| E8 | Air speed detection out of control | |
| E7 | EEPROM error | |
| E6 | Zero crossing detection error | |
| E5 | Outdoor unit fault protection | |
| E4 | T2B sensor fault | |
| E3 | T2A sensor fault | |
| E2 | T1 sensor fault | |
| E1 | Communication fault | |
| E0 | Phase order error or phase loss | |
| 07# | | |
| 06# | | |
| 05# | | |
| 04# | | |
| 03# | Fault of communication between centralized controller and computer (gateway) | |
| 02# | Fault of communication between centralized controller and functional module | |
| 01# | Fault of communication between centralized controller and network interface module | |
| 00# | Fault of communication between network interface module and main control board | |

| Protection code | Protection content | Description |
|-----------------|---|-------------|
| PF | Other protection | |
| PE | Reserved | |
| PD | Reserved | |
| PC | Reserved | |
| PB | Reserved | |
| PA | Reserved | |
| P9 | Reserved | |
| P8 | Over-current of compressor | |
| P7 | Power supply over-voltage and undervoltage protection | |
| P6 | Discharge low pressure protection | |
| P5 | Discharge high pressure protection | |
| P4 | Discharge pipe temperature protection | |
| P3 | Compressor temperature protection | |
| P2 | Condenser high-temperature protection | |
| P1 | Anti cool air or defrost protection | |
| P0 | Evaporator temperature protection | |

2.5 Technical indices and requirements

1. EMC, EMI comply with the CE certification requirements.
2. Electrical safety comply with GB4706.32-2004, GB/T7725-2004.

(2020551A7919)

CE



更改内容，此页不做菲林

C升级为D

封面封底页更新开利logo