

User Guide

Controller for temperature control

AK-CC 350

ADAP-KOOL® Refrigeration control systems



Introduction

Application

- The controller is used for temperature control refrigeration appliances in supermarkets
- With many predefined applications one unit will offer you many options. Flexibility has been planned both for new installations and for service in the refrigeration trade

Principle

The controller contains a temperature control where the signal can be received from one or two temperature sensors. The thermostat sensors are either placed in the cold air flow after the evaporator, in the warm air flow just before the evaporator, or both. A setting will determine how great an influence the two signals are to have on the control.

A measurement of the defrost temperature can be obtained directly through the use of an S5 sensor or indirectly through the use of the S4 measurement. Four relays will cut the required functions in and out – the application determines which. The options are the following:

- Refrigeration (compressor or relay)
- Fan
- Defrost
- Rail heat
- Alarm
- Light
- Fans for hotgas defrost
- Refrigeration 2 (compressor 2 or relay 2)

The different applications are described on page 6.

Advantages

- Many applications in the same unit
- The controller has integrated refrigeration-technical functions, so that it can replace a whole collection of thermostats and timers
- Can control two compressors
- Fixed MODBUS data communication
- Quick setup
- Two temperature references
- Digital inputs for various functions
- Clock function with super cap backup
- HACCP (Hazard Analysis and Critical Control Points)
 - Temperature monitoring and registration of period with too high temperature (see also page 19)
 - Factory calibration that will guarantee a better measuring accuracy than stated in the standard EN 441-13 without subsequent calibration (Pt 1000 ohm sensor)

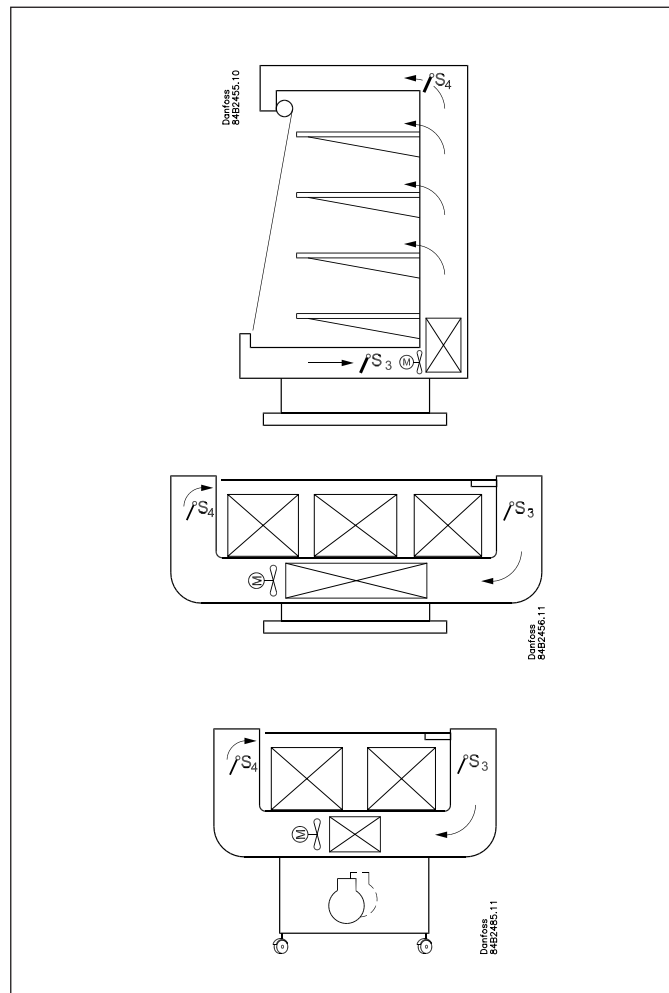
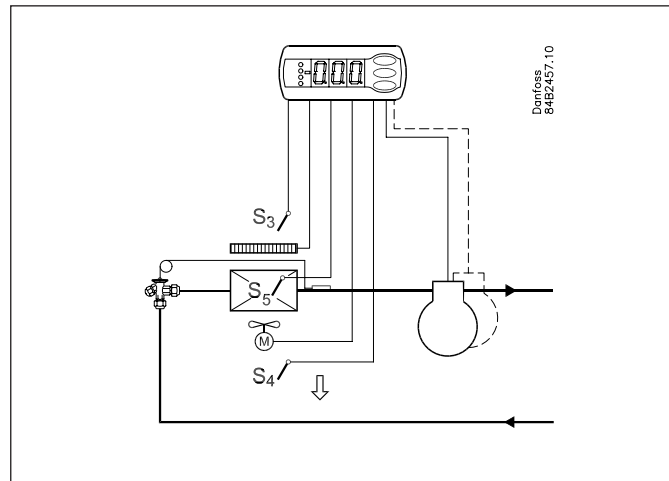

Contents

Introduction	2	Menu survey	20
Operation	3	Ordering	23
Applications	6	Connections	24
Survey of functions	8	External display	25
Operation	18	Data	26

Operation

Sensors

Up to two thermostat sensors can be connected to the controller. The relevant application determines how.

A sensor in the air before the evaporator:

This connection is primarily used when control is based on area.

A sensor in the air after the evaporator:

This connection is primarily used when refrigeration is controlled and there is a risk of a too low temperature near the products.

A sensor before and after the evaporator:

This connection offers you the possibility of adapting the thermostat, the alarm thermostat and the display to the relevant application. The signal to the thermostat, the alarm thermostat and the display is set as a weighted value between the two temperatures, and 50% will for example give the same value from both sensors.

The signal to the thermostat, the alarm thermostat and the display can be set independently of one another.

Defrost sensor

The best signal concerning the evaporator's temperature is obtained from a defrost sensor mounted directly on the evaporator. Here the signal may be used by the defrost function, so that the shortest and most energy-saving defrost can take place.

If a defrost sensor is not required, defrost can be stopped based on time, or S4 can be selected.

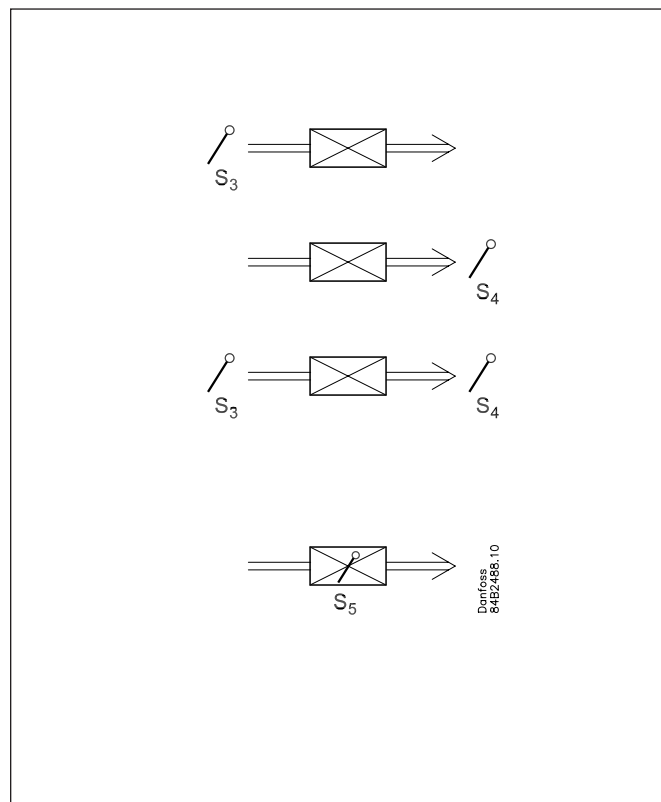

Control of two compressors

This control is used for controlling two compressors of the same size. The principle for control is that one of the compressors connects at $\frac{1}{2}$ the differential of the thermostat, and the other at the full differential. When the thermostat cuts in the compressor with the fewest operating hours is started. The other compressor will only start after a set time delay, so that the load will be divided between them. The time delay has a higher priority than the temperature.

When the air temperature has dropped by half the differential the one compressor will stop, the other will continue working and not stop until the required temperature is achieved.

The compressors used must be of a type that is capable of starting up against a high pressure.

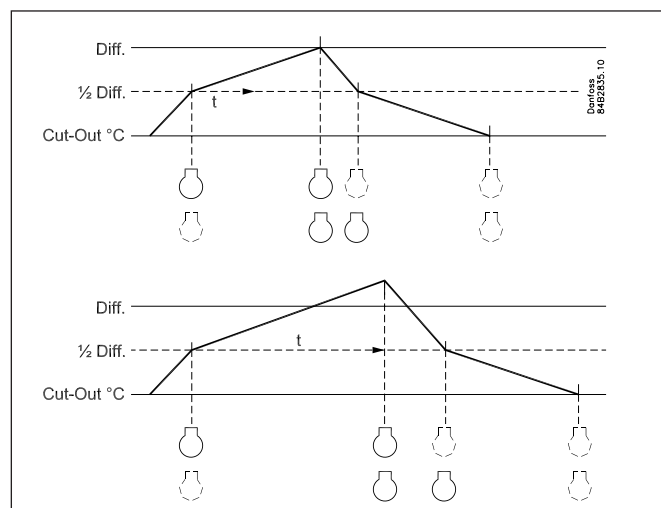

Change of temperature reference

In an impulse appliance, for example, used for various product groups. Here the temperature reference is changed easily with a contact signal on a digital input. The signal raises the normal thermostat value by a predefined amount. At the same time the alarm limits with the same value are displaced accordingly.

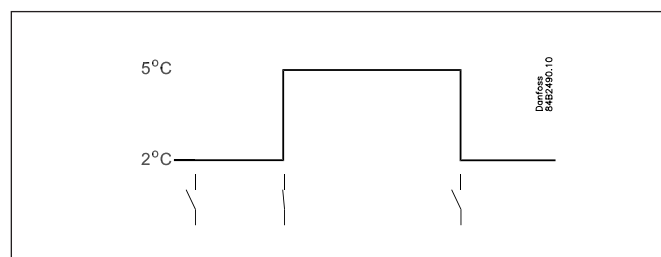

Digital inputs

There are two digital inputs both of which can be used for the following functions:

- Case cleaning
- Door contact function with alarm
- Starting a defrost
- Coordinated defrost
- Change-over between two temperature reference
- Retransmission of a contact's position via data communication

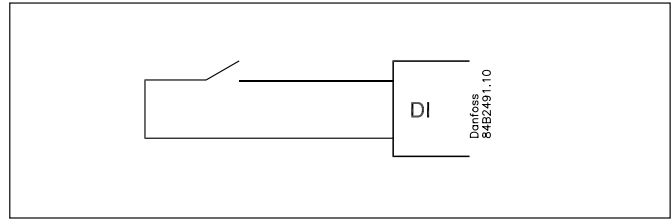

Case cleaning function

This function makes it easy to steer the refrigeration appliance through a cleaning phase. Via three pushes on a switch you change from one phase to the next phase.

The first push stops the refrigeration – the fans keep working

“Later”: The next push stops the fans

“Still later”: The next push restarts refrigeration

The different situations can be followed on the display.

-	+	+	°C
1	÷	+	Fan
2	÷	÷	Off
3	+	+	°C

On the network a cleaning alarm is transmitted to the system unit. This alarm can be “logged” so that proof of the sequence of events is provided.

Door contact function

In cold rooms and frost rooms the door switch can switch the light on and off, start and stop the refrigeration and give alarm if the door has remained open for too long.

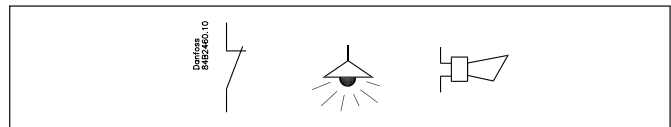

Defrost

Depending on the application you may choose between the following defrost methods:

Natural: Here the fans are kept operating during the defrost

Electric: The heating element is activated

Brine: The valve is kept open so that the brine can flow through the evaporator

Hot gas: Here the solenoid valves are controlled so that the hot gas can flow through the evaporator

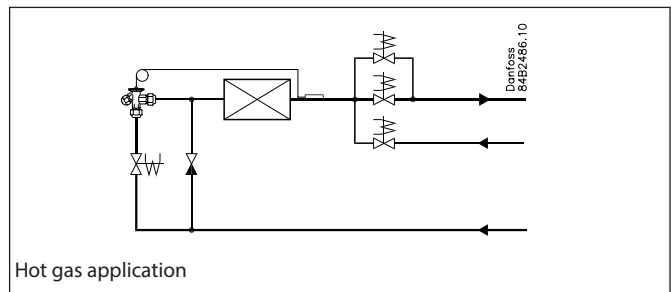

Start of defrost

A defrost can be started in different ways

Interval: Defrost is started at fixed time intervals, say, every eighth hour

Refrigeration time:

Defrost is started at fixed refrigeration time intervals, in other words, a low need for refrigeration will “postpone” the coming defrost

Schedule: Here defrost can be started at fixed times of the day and night. However, max. 6 times

Contact: Defrost is started with a contact signal on a digital input

Network: The signal for defrost is received from a system unit via the data communication

S5 temp: In 1:1 systems the efficiency of the evaporator can be followed. Icing-up will start a defrost.

Manual: An extra defrost can be activated from the controller's lower-most button

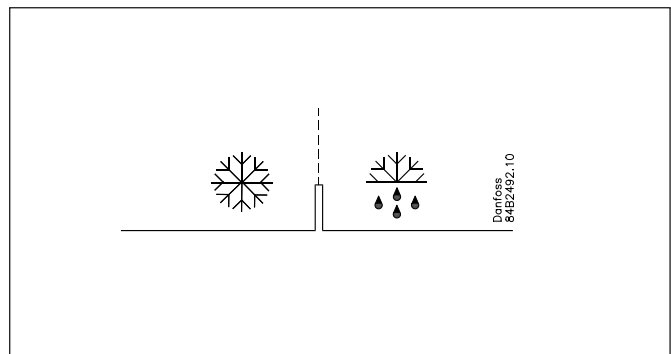

All the mentioned methods can be used at random – if just one them is activated a defrost will be started.

Coordinated defrost

There are two ways in which coordinated defrost can be arranged. Either with wire connections between the controllers or via data communication

Wire connections

One of the controllers is defined to be the controlling unit and a battery module may be fitted in it so that the clock is ensured backup. When a defrost is started all the other controllers will follow suit and likewise start a defrost. After the defrost the individual controllers will move into waiting position. When all are in waiting position there will be a change-over to refrigeration. (If just one in the group demands defrost, the others will follow suit).

Defrost via data communication

Defrosting is started by the override function in a system manager, which also coordinates the defrosting stop.

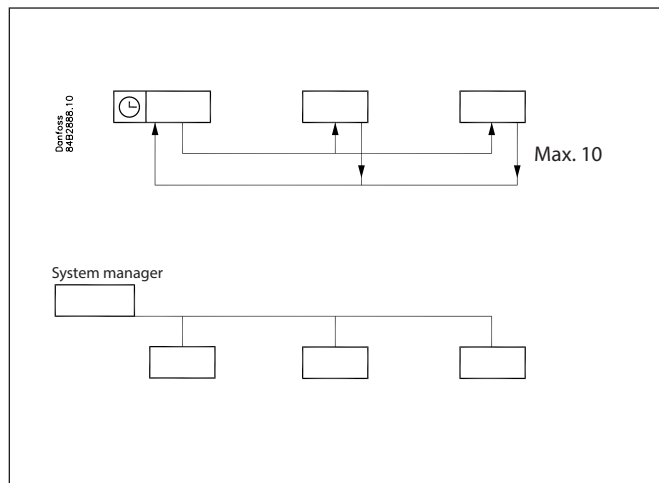

Defrost on demand

1 Based on refrigeration time

When the aggregate refrigeration time has passed a fixed time, a defrost will be started.

2 Based on temperature

The controller will constantly follow the temperature at S5. Between two defrosts the S5 temperature will become lower the more the evaporator ices up (the compressor operates for a longer time and pulls the S5 temperature further down). When the temperature passes a set allowed variation the defrost will be started.

This function can only work in 1:1 systems

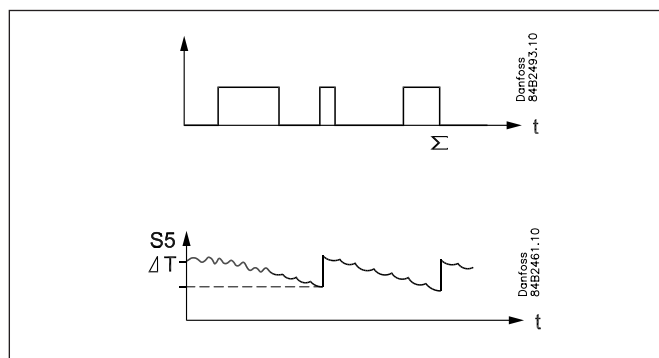

Extra module

The controller can afterwards be fitted with an insertion module if the application requires it. The controller has been prepared with plug, so the module simply has to be pushed in.

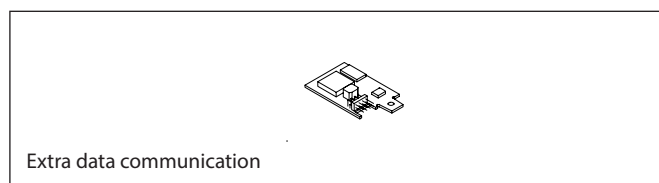

External display

If an external display is connected to the controller, data communication can also be connected, though this requires the installation of a separate data communication module.

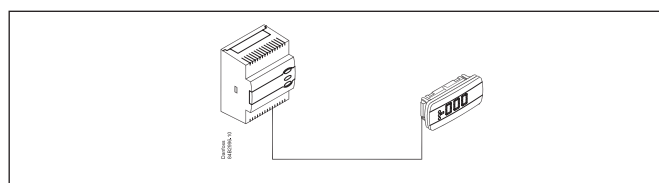

Applications

Here is a survey of the controller's field of application.

A setting will define the relay outputs so that the controller's interface will be targeted to the chosen application.

On page 20 you can see the relevant settings for the respective wiring diagrams.

S3 and S4 are temperature sensors. The application will determine whether either one or the other or both sensors are to be used. S3 is placed in the air flow before the evaporator. S4 after the evaporator.

A percentage setting will determine according to what the control is to be based. S5 is a defrost sensor and is placed on the evaporator.

DI1 and DI2 are contact functions that can be used for one of the following functions: door function, alarm function, defrost start, external main switch, night operation, change of thermostat reference, appliance cleaning, forced refrigeration or coordinated defrost. See the functions in settings o02 and o37.

Refrigeration control with one compressor

The functions are adapted to small refrigeration systems which either may be refrigeration appliances or cold rooms. The three relays can control the refrigeration, the defrost and the fans, and the fourth relay can be used for either alarm function, light control or rail heat control

- The alarm function can be linked up with a contact function from a door switch. If the door remains open longer than allowed there will be an alarm.
- The light control can also be linked up with a contact function from a door switch. An open door will switch on the light and it will remain lit for two minutes after the door has been closed again.
- The rail heat function can be used in refrigeration or freezing appliances or on the door's heating element for frost rooms.

The fans can be stopped during defrost and they may also follow a door switch's open/close situation.

There are several other functions for the alarm function as well as the light control, rail heat control and fans. Please refer to the respective settings.

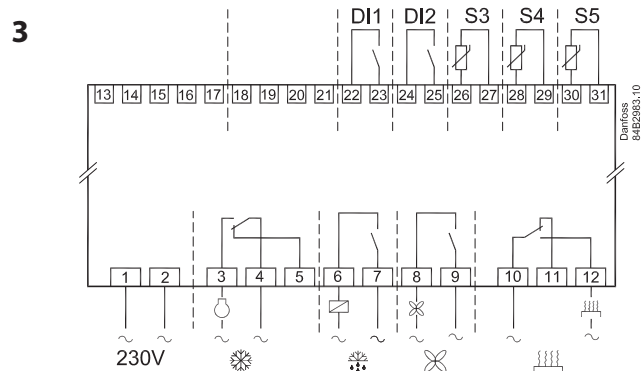
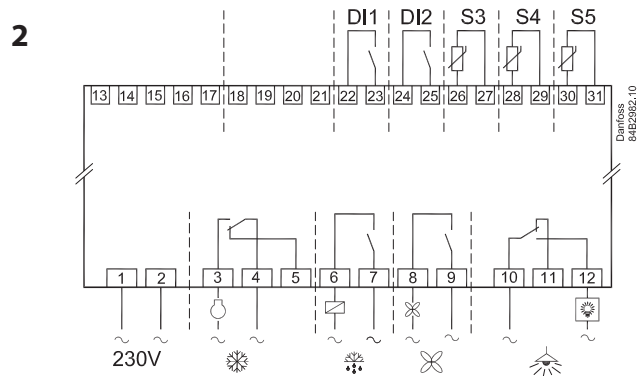
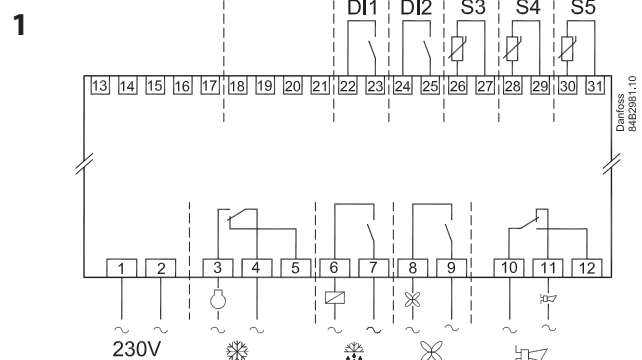

Hot gas defrost

This type of connection can be used on systems with hotgas defrost, but only in small systems in, say, supermarkets – the functional content has **not** been adapted to systems with large charges. Relay 1's change-over function can be used by the bypass valve and/or the hot gas valve.

Relay 2 is used for refrigeration.

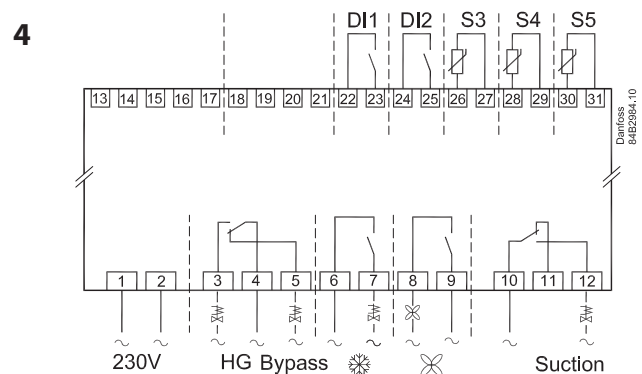

Refrigeration control with two compressors

This group of applications can be used if the controller is to cut two compressors in and out. The functions can be compared with wiring diagrams 1 to 3, but instead of controlling fans the relay is here used for compressor 2.

The two compressors must be of the same size. When the controller demands refrigeration it will first cut in the compressor with the shortest operating time. After the time delay the second compressor will be cut in.

When the temperature has dropped to "the middle of the differential", the compressor with the longest operation time will be cut out.

If the running compressor does not manage to reduce the temperature to the cutout point, the other compressor will be cut in again. This happens when the temperature reaches the top part of the differential. If the temperature is instead "stuck" in the differential for two hours, there will be a change-over between the two compressors so that the operating time can be equalised. The two compressors must be of a type that can start up against a high pressure.

The compressors's settings for "Min On time" and "Min Off time" will always have top priority during normal regulation. But if one of the override functions is activated, the "Min On time" will be disregarded.

If the controller is to cut 2 compressor and 1 fan in and out, relay 4 must cut the fan in and out. This function is activated in application 10.

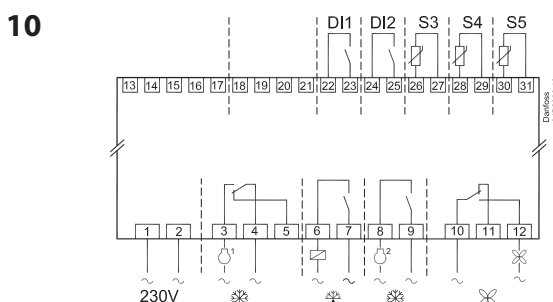
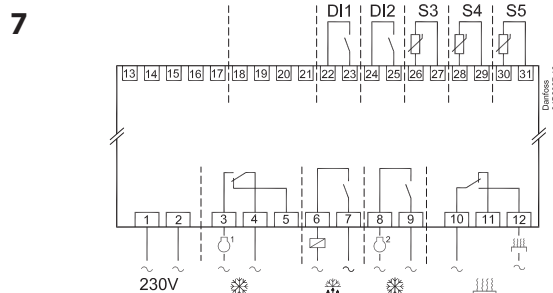
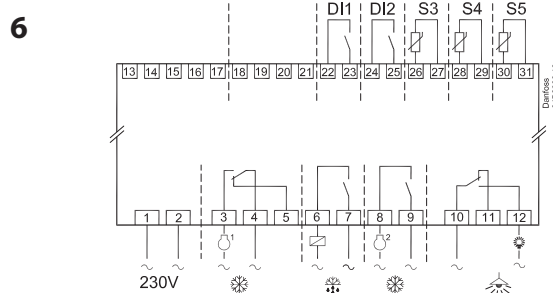
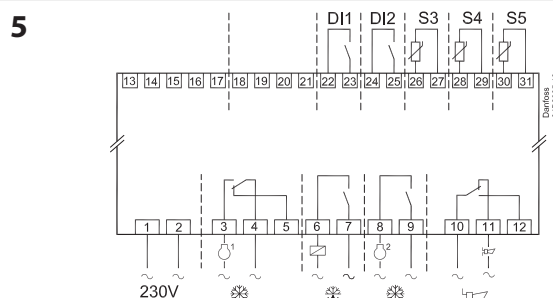

Simple refrigeration with defrost

This application can be used where there is only regulation of refrigeration and defrost.

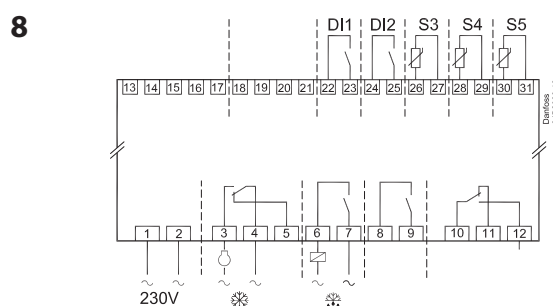

Heating function

This application is the same as under 1, but a heating function has been added which protects the unit against too low temperature. The defrost function's heating element is here used for heating.

This application is used where the temperature can go below the set cutout temperature for the refrigeration. To ensure that the temperature will not become too low the heating element is activated x degrees below the reference value.

The S3 sensor must be mounted. It supplies the signal when there is heating.

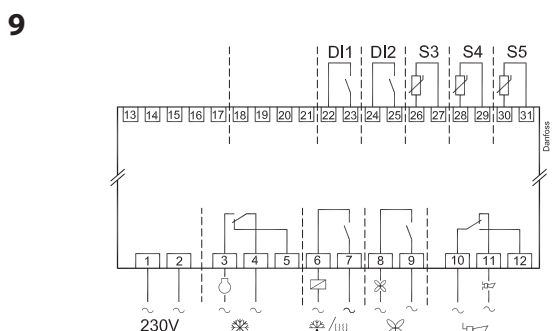

Survey of functions

Function	Parameter	Parameter by operation via data communication
Normal display		
Normally the temperature value from one of the two thermostat sensors S3 or S4 or a mixture of the two measurements is displayed. In o17 the ratio is determined.		Display air (u56)
Thermostat		Thermostat control
Set point Regulation is based on the set value plus a displacement, if applicable. The value is set via a push on the centre button. The set value can be locked or limited to a range with the settings in r02 and r03. The reference at any time can be seen in "u28 Temp. ref"		Cutout °C
Differential When the temperature is higher than the reference + the set differential, the compressor relay will be cut in. It will cut out again when the temperature comes down to the set reference.	r01	Differential
Set point limitation The controller's setting range for the set point may be narrowed down, so that much too high or much too low values are not set accidentally - with resulting damages.		
To avoid a too high setting of the set point, the max. allowable reference value must be lowered.	r02	Max cutout °C
To avoid a too low setting of the set point, the min. allowable reference value must be increased.	r03	Min cutout °C
Correction of the display's temperature showing If the temperature at the products and the temperature received by the controller are not identical, an offset adjustment of the shown display temperature can be carried out.	r04	Disp. Adj. K
Temperature unit Set here if the controller is to show temperature values in °C or in °F.	r05	Temp. unit °C=0. / °F=1 (Only °C on AKM, whatever the setting)
Correction of signal from S4 Compensation possibility through long sensor cable	r09	Adjust S4
Correction of signal from S3 Compensation possibility through long sensor cable	r10	Adjust S3
Start / stop of refrigeration With this setting refrigeration can be started, stopped or a manual override of the outputs can be allowed. Start / stop of refrigeration can also be accomplished with the external switch function connected to a DI input. Stopped refrigeration will give a "Standby alarm".	r12	Main Switch 1: Start 0: Stop -1: Manual control of outputs allowed
Night setback value The thermostat's reference will be the set point plus this value when the controller changes over to night operation. (Select a negative value if there is to be cold accumulation.)	r13	Night offset
Selection of thermostat sensor Here you define the sensor the thermostat is to use for its control function. S3, S4, or a combination of them. With the setting 0%, only S3 is used (Sin). With 100%, only S4. (For application 9 and S3 sensor must be used)	r15	Ther. S4 %
Heating function The function uses the defrost function's heating element for raising the temperature. The function enters into force a number of degrees (r36) below the actual reference and cuts out again with a differential of 2 degrees. Regulation is carried out with 100% signal from the S3 sensor. The fans will be operating when there is heating. The fans and the heating function will stop if door function has been selected and the door is opened. Where this function is used an external safety cutout should also be installed, so that superheating of the heating element cannot take place. Remember to set D01 to electrical defrosting.	r36	HeatStartRel

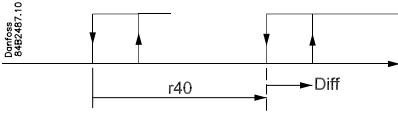
<p>Activation of reference displacement When the function is changed to ON the thermostat reference will be displaced by the value in r40. Activation can also take place via input DI1 or DI2 (defined in o02 or o37).</p> 	r39	Th. offset
<p>Value of reference displacement The thermostat reference and the alarm values are shifted the following number of degrees when the displacement is activated. Activation can take place via r39 or input DI</p>	r40	Th. offset K
		Night setback (start of night signal)
		Forced cool. (start of forced cooling)
Alarm		Alarm settings
<p>The controller can give alarm in different situations. When there is an alarm all the light-emitting diodes (LED) will flash on the controller front panel, and the alarm relay will cut in.</p>		With data communication the importance of the individual alarms can be defined. Setting is carried out in the "Alarm destinations" menu.
<p>Alarm delay (short alarm delay) If one of the two limit values is exceeded, a timer function will commence. The alarm will not become active until the set time delay has been passed. The time delay is set in minutes.</p>	A03	Alarm delay
<p>Time delay for door alarm The time delay is set in minutes. The function is defined in o02 or in o37.</p>	A04	DoorOpen del
<p>Time delay for cooling (long alarm delay) This time delay is used during start-up, during defrost, immediately after a defrost. There will be change-over to the normal time delay (A03) when the temperature has dropped below the set upper alarm limit. The time delay is set in minutes.</p>	A12	Pulldown del
<p>Upper alarm limit Here you set when the alarm for high temperature is to start. The limit value is set in °C (absolute value). The limit value will be raised during night operation. The value is the same as the one set for night setback, but will only be raised if the value is positive. The limit value will also be raised in connection with reference displacement r39.</p>	A13	HighLim Air
<p>Lower alarm limit Here you set when the alarm for low temperature is to start. The limit value is set in °C (absolute value). The limit value will also be raised in connection with reference displacement r39.</p>	A14	LowLim Air
<p>Delay of a DI1 alarm A cut-out/cut-in input will result in alarm when the time delay has been passed. The function is defined in o02.</p>	A27	AI.Delay DI1
<p>Delay of a DI2 alarm A cut-out/cut-in input will result in alarm when the time delay has been passed. The function is defined in o37</p>	A28	AI.Delay DI2
<p>Signal to the alarm thermostat Here you have to define the ratio between the sensors which the alarm thermostat has to use. S3, S4 or a combination of the two. With setting 0% only S3 is used. With 100% only S4 is used</p>	A36	Alarm S4%
		Reset alarm
		EKC error
Compressor		Compressor control
<p>The compressor relay works in conjunction with the thermostat. When the thermostat calls for refrigeration will the compressor relay be operated.</p> <p>Running times To prevent irregular operation, values can be set for the time the compressor is to run once it has been started. And for how long it at least has to be stopped. The running times are not observed when defrosts start.</p>		
Min. ON-time (in minutes)	c01	Min. On time
Min. OFF-time (in minutes)	c02	Min. Off time

<p>Time delay for couplings of two compressors Settings indicate the time that has to elapse from the first relay cuts in and until the next relay has to cut in.</p>	c05	Step delay
<p>Reversed relay function for D01 0: Normal function where the relay cuts in when refrigeration is demanded 1: Reversed function where the relay cuts out when refrigeration is demanded (this wiring produces the result that there will be refrigeration if the supply voltage to the controller fails).</p>	c30	Cmp relay NC
<p>External relay Here it is possible to force the build in relays to connect in the voltage's zero crossing. The lifetime of the relays is increased, or the load can be increased. The function should not be activated if contactors are connected to one or more of the controller's relays, as this will result in a reduction of the contactors lifetime. 0: The load is connected directly to the controller's relays (zero-crossing activated) Relay contact and controller supply must use same phase. 1: The controller's relays must draw an external contactor (zero-crossing cancelled)</p>	c70	Ext. Relay
<p>The LED on the controller's front will show whether refrigeration is in progress.</p>		Comp Relay Here you can read the status of the compressor relay, or you can force-control the relay in the "Manual control" mode
<p>Defrost</p>		Defrost control
<p>The controller contains a timer function that is zero set after each defrost start. The timer function will start a defrost if/when the interval time is passed. The timer function starts when voltage is connected to the controller, but it is displaced the first time by the setting in d05. If there is power failure the timer value will be saved and continue from here when the power returns. This timer function can be used as a simple way of starting defrosts, but it will always act as safety defrost if one of the subsequent defrost starts is not received. The controller also contains a real-time clock. By means of settings of this clock and times for the required defrost times, defrost can be started at fixed times of the day. Defrost start can also be accomplished via data communication, via contact signals or manual start-up. All starting methods will function in the controller. The different functions have to be set, so that defrosts do not "come tumbling" one after the other. Defrost can be accomplished with electricity, hot gas or brine. The actual defrost will be stopped based on time or temperature with a signal from a temperature sensor.</p>		
<p>Defrost method Here you set whether defrost is to be accomplished with electricity, gas, brine or "non". During defrost the defrost relay will be cut in. (With brine the "refrigeration control valve" will be kept open during defrost)</p>	d01	Def. method 0 = non 1 = El 2 = Gas 3 = Brine
<p>Defrost stop temperature The defrost is stopped at a given temperature which is measured with a sensor (the sensor is defined in d10). The temperature value is set.</p>	d02	Def. Stop Temp
<p>Interval between defrost starts The function is zero set and will start the timer function at each defrost start. When the time has expired the function will start a defrost. The function is used as a simple defrost start, or it may be used as a safeguard if the normal signal fails to appear. If master/slave defrost without clock function or without data communication is used, the interval time will be used as max. time between defrosts. If a defrost start via data communication does not take place, the interval time will be used as max. time between defrosts. When there is defrost with clock function or data communication, the interval time must be set for a somewhat longer period of time than the planned one, as the interval time will otherwise start a defrost which a little later will be followed by the planned one. In connection with power failure the interval time will be maintained, and when the power returns the interval time will continue from the maintained value. The interval time is not active when set to 0.</p>	d03	Def Interval (0=off)
<p>Max. defrost duration This setting is a safety time so that the defrost will be stopped if there has not already been a stop based on temperature or via coordinated defrost.</p>	d04	Max Def. time

<p>Time staggering for defrost cut ins during start-up The function is only relevant if you have several refrigeration appliances or groups where you want the defrost to be staggered in relation to one another. The function is furthermore only relevant if you have chosen defrost with interval start (d03). The function delays the interval time d03 by the set number of minutes, but it only does it once, and this at the very first defrost taking place when voltage is connected to the controller. The function will be active after each and every power failure.</p>	d05	Time Stag.
<p>Drip-off time Here you set the time that is to elapse from a defrost and until the compressor is to start again. (The time when water drips off the evaporator).</p>	d06	DripOff time
<p>Delay of fan start after defrost Here you set the time that is to elapse from compressor start after a defrost and until the fan may start again. (The time when water is "tied" to the evaporator).</p>	d07	FanStartDel
<p>Fan start temperature The fan may also be started a little earlier than mentioned under "Delay of fan start after defrost", if the defrost sensor S5 registers a lower value than the one set here.</p>	d08	FanStartTemp
<p>Fan cut in during defrost Here you can set whether fan is to operate during defrost. 0: Stopped (Runs during pump down) 1: Running (stopped during "fan delay") 2: Running during pump down and defrost. After that stopped</p>	d09	FanDuringDef
<p>Defrost sensor Here you define the defrost sensor. 0: None, defrost is based on time 1: S5 2: S4</p>	d10	DefStopSens.
<p>Pump down delay Set the time where the evaporator is emptied of refrigerant prior to the defrost.</p>	d16	Pump dwn del.
<p>Drain delay (only in connection with hot gas) Set the time where the evaporator is emptied of condensed refrigerant after the defrost.</p>	d17	Drain del
<p>Defrost on demand – aggregate refrigeration time Set here is the refrigeration time allowed without defrosts. If the time is passed, a defrost will be started. With setting = 0 the function is cut out.</p>	d18	MaxTherRunT
<p>Defrost on demand – S5 temperature The controller will follow the effectivity of the evaporator, and via internal calculations and measurements of the S5 temperature it will be able to start a defrost when the variation of the S5 temperature becomes larger than required. Here you set how large a slide of the S5 temperature can be allowed. When the value is passed, a defrost will start. The function can only be used in 1:1 systems when the evaporating temperature will become lower to ensure that the air temperature will be maintained. In central systems the function must be cut out. With setting = 20 the function is cut out</p>	d19	CutoutS5Dif.
<p>Delay of the hot gas injection Can be used when vales of the type PMLX and GPLX are used. Time is set so that the valve is closed completely before the hot gas is turned on.</p>	d23	--
<p>If you wish to see the temperature at the defrost sensor, push the controller's lowermost button.</p>		Defrost temp.
<p>If you wish to start an extra defrost, push the controller's lowermost button for four seconds. You can stop an ongoing defrost in the same way</p>		Def Start Here you can start a manual defrost
<p>The LED on the controller's front will indicate whether a defrost is going on.</p>		Defrost Relay Here you can read the defrost relay status or you can force-control the relay in "Manual control" mode.
		Hold After Def Shows ON when the controller is operating with coordinated defrost.
		Defrost State Status on defrost 1= pump down / defrost

Fan		Fan control
Fan stopped at cut-out compressor Here you can select whether the fan is to be stopped when the compressor is cut out	F01	Fan stop CO (Yes = Fan stopped)
Delay of fan stop when compressor is cut out If you have chosen to stop the fan when the compressor is cut out, you can delay the fan stop when the compressor has stopped. Here you can set the time delay.	F02	Fan del. CO
Fan stop temperature The function stops the fans in an error situation, so that they will not provide power to the appliance. If the defrost sensor registers a higher temperature than the one set here, the fans will be stopped. There will be re-start at 2 K below the setting. The function is not active during a defrost or start-up after a defrost. With setting +50°C the function is interrupted.	F04	FanStopTemp.
The LED on the controller's front will indicate whether a defrost is going on.		Fan Relay Here you can read the fan relay status, or force-control the relay in "Manual control" mode.
HACCP		HACCP
HACCP temperature Here you can see the temperature measurement that transmits signal to the function	h01	HACCP temp.
Last too high HACCP temperature was registered in connection with: (Value can be read out). H01: Temperature exceeding during normal regulation. H02: Temperature exceeding during power failure. Battery backup controls the times. H03: Temperature exceeding during power failure. No control of times.	h02	-
Last time the HACCP temperature was exceeded: Year	h03	-
Last time the HACCP temperature was exceeded: Month	h04	-
Last time the HACCP temperature was exceeded: Day	h05	-
Last time the HACCP temperature was exceeded: Hour	h06	-
Last time the HACCP temperature was exceeded: Minute	h07	-
Last exceeding: Duration in hours	h08	-
Last exceeding: Duration in minutes	h09	-
Peak temperature The highest measured temperature will continuously be saved when the temperature exceeds the limit value in h12. The value can be read out until the next time the temperature exceeds the limit value. After that it is overwritten with the new measurements.	h10	Max.temp.
Selection of function 0: No HACCP function 1: S3 and/or S4 used as sensor. Definition takes place in h14. 2: S5 used as sensor.	h11	HACCP sensor
Alarm limit Here you set the temperature value at which the HACCP function is to enter into force. When the value becomes higher than the set one, the time delay starts.	h12	HACCP limit
Time delay for the alarm (only during normal regulation). When the time delay has been passed the alarm is activated.	h13	HACCP delay
Selection of sensors for the measuring If the S4 sensor and/or the S3 sensor is used, the ratio between them must be set. At setting 100% only S4 is used. At setting 0% only S3 is used.	h14	HACCP S4%
Real-time clock		
You can set up to six individual times for defrost starts for each 24-hour period. There is also a date indication used for registration of temperature measurements.		(Times cannot be set via data communication. Settings are only relevant when there is no data communication).
Defrost start, hour setting	t01-t06	
Defrost start, minute setting (1 and 11 belong together, etc.) When all t01 to t16 equal 0 the clock will not start defrosts.	t11-t16	
Clock: Hour setting	t07	
Clock: Minute setting	t08	
Clock: Date setting	t45	
Clock: Month setting	t46	
Clock: Year setting	t47	

Miscellaneous		Miscellaneous
Delay of output signal after start-up After start-up or a power failure the controller's functions can be delayed so that overloading of the electricity supply network is avoided. Here you can set the time delay.	o01	DelayOfOutp.
Digital input signal - DI1 The controller has a digital input 1 which can be used for one of the following functions: Off: The input is not used 1) Status display of a contact function 2) Door function. When the input is open it signals that the door is open. The refrigeration and the fans are stopped. When the time setting in "A4" is passed, an alarm will be given and refrigeration will be resumed. 3) Door alarm. When the input is open it signals that the door is open. When the time setting in "A4" is passed, there will be alarm. 4) Defrost. The function is started with a pulse signal. The controller will register when the DI input is activated. The controller will then start a defrost cycle. If the signal is to be received by several controllers it is important that ALL connections are mounted the same way (DI to DI and GND to GND). 5) Main switch. Regulation is carried out when the input is short-circuited, and regulation is stopped when the input is put in pos. OFF. 6) Night operation. When the input is short-circuited, there will be regulation for night operation. 7) Reference displacement when DI1 is short-circuited. Displacement with "r40". 8) Separate alarm function. Alarm will be given when the input is short-circuited. 9) Separate alarm function. Alarm will be given when the input is opened. (For 8 and 9 the time delay is set in A27) 10) Case cleaning. The function is started with a pulse signal. Cf. also description on page 4. 11) Forced refrigeration at hotgas defrost when the input is short-circuited.	o02	DI 1 Config. Definition takes place with the numerical value shown to the left. (0 = off) DI state (Measurement) The DI input's present status is shown here. ON or OFF.
Data communication If the controller is built into a network with data communication, it must have an address, and the system manager of the data communication must then know this address. The installation of the data communication cable has been mentioned in a separate document "RC8AC". The address is set between 0 and 240. The address is sent to the system manager when menu o04 is set to 'ON', or when the system manager's scanning function is activated. IMPORTANT: Before setting o04 or the scanning function is activated, you MUST set o61. Otherwise you will send the incorrect data set (o04 is only to be used if the data communication is LON).	o03	After installation of data communication the controller can be operated on an equal footing with the other controllers in ADAP-KOOL® refrigeration controls.
	o04	
Access code 1 (Access to all settings) If the settings in the controller are to be protected with an access code you can set a numerical value between 0 and 100. If not, you can cancel the function with setting 0. (99 will always give you access).	o05	-
Sensor type Normally a Pt 1000 sensor with great signal accuracy is used. But you can also use a sensor with another signal accuracy. That may either be a PTC sensor (1000 ohm) or an NTC sensor (5000 Ohm at 25°C). All the mounted sensors must be of the same type.	o06	SensorConfig Pt = 0 PTC = 1 NTC = 2
Display step Yes: Gives steps of 0.5° No: Gives steps of 0.1°	o15	Disp. Step = 0.5
Max. standby time after coordinated defrost When a controller has completed a defrost it will wait for a signal which tells that the refrigeration may be resumed. If this signal fails to appear for one reason or another, the controller will itself start the refrigeration when this standby time has elapsed.	o16	Max HoldTime
Select signal for the display S4% Here you define the signal to be shown by the display. S3, S4, or a combination of the two. With setting 0% only S3 is used. With 100% only S4.	o17	Disp. S4%

<p>Digital input signal - D2 The controller has a digital input 2 which can be used for one of the following functions: Off: The input is not used.</p> <ol style="list-style-type: none"> 1) Status display of a contact function 2) Door function. When the input is open it signals that the door is open. The refrigeration and the fans are stopped. When the time setting in "A4" is passed, an alarm will be given and refrigeration resumed. 3) Door alarm. When the input is open it signals that the door is open. When the time setting in "A4" is passed an alarm will be given. 4) Defrost. The function is started with a pulse signal. The controller will register when the DI input is activated. The controller will then start a defrost cycle. If the signal is to be received by several controllers it is important that ALL connections are mounted the same way (DI to DI and GND to GND). 5) Main switch. Regulation is carried out when the input is short-circuited, and regulation is stopped when the input is put in pos. OFF. 6) Night operation. When the input is short-circuited, there will be regulation for night operation. 7) Reference displacement when DI2 is short-circuited. Displacement with "r40". 8) Separate alarm function. Alarm will be given when the input is short-circuited. 9) Separate alarm function. Alarm will be given when the input is opened. 10) Case cleaning. The function is started with a pulse signal. Cf. also description on page 4. 11) Forced refrigeration at hot gas defrost when the input is short-circuited. 12) The input is used for coordinated defrost in conjunction with other controllers of the same type 	o37	DI2 config.
<p>Configuration of light function (relay 4 in applications 2 and 6)</p> <ol style="list-style-type: none"> 1) The relay cuts in during day operation 2) The relay to be controlled via data communication 3) The relay to be controlled by the door switch defined in either o02 or o37 where the setting is selected to either 2 or 3. When the door is opened the relay will cut in. When the door is closed again there will be a time delay of two minutes before the light is switched off. 	o38	Light config
<p>Activation of light relay The light relay can be activated here, but only if defined in o38 with setting 2.</p>	o39	Light remote
<p>Rail heat during day operation The ON period is set as a percentage of the time</p>	o41	Railh.ON day%
<p>Rail heat during night operation The ON period is set as a percentage of the time</p>	o42	Railh.ON ngt%
<p>Rail heat cycle The period of time for the aggregate ON time + OFF time is set in minutes</p>	o43	Railh. cycle
<p>Case cleaning The status of the function can be followed here or the function can be started manually.</p> <p>0 = Normal operation (no cleaning) 1 = Cleaning with fans operating. All other outputs are Off. 2 = Cleaning with stopped fans. All outputs are Off.</p> <p>If the function is controlled by a signal at the DI1 or DI2 input, the relevant status can be seen here in the menu.</p>	o46	Case clean
<p>Selection of application The controller can be defined in various ways. Here you set which of the 10 applications is required. On page 6 you can see a survey of applications. <i>This menu can only be set when regulation is stopped, i.e. "r12" is set to 0.</i></p>	o61	--- Appl. Mode (only output in Danfoss only)
<p>Transfer a set of presetting to the controller It is possible to select a quick setting of a number of parameters. It depends on whether an application or a room is to be controlled and whether defrost is to be stopped based on time or based on temperature. The survey can be seen on page 22. <i>This menu can only be set when regulation is stopped, i.e. "r12" is set to 0.</i></p> <p>After the setting the value will return to 0. Any subsequent adjustment/setting of parameters can be made, as required.</p>	o62	-
<p>Access code 2 (Access to adjustments) There is access to adjustments of values, but not to configuration settings. If the settings in the controller are to be protected with an access code you can set a numerical value between 0 and 100. If not, you can cancel the function with setting 0. If the function is used, access code 1 (o05) must also be used.</p>	o64	-
<p>Save as factory setting With this setting you save the controller's actual settings as a new basic setting (the earlier factory settings are overwritten).</p>	o67	-
		<p>--- Night Setback 0=Day 1=Night</p>

Service		Service
Temperature measured with S5 sensor	u09	S5 temp.
Status on DI1 input. on/1=closed	u10	DI1 status
Temperature measured with S3 sensor	u12	S3 air temp
Status on night operation (on or off) 1=closed	u13	Night Cond.
Temperature measured with S4 sensor	u16	S4 air temp
Thermostat temperature	u17	Ther. air
Read the present regulation reference	u28	Temp. ref.
Status on DI2 output. on/1=closed	u37	DI2 status
Temperature shown on display	u56	Display air
Measured temperature for alarm thermostat	u57	Alarm air
** Status on relay for cooling	u58	Comp1/LLSV
** Status on relay for fan	u59	Fan relay
** Status on relay for defrost	u60	Def. relay
** Status on relay for rail heat	u61	Railh. relay
** Status on relay for alarm	u62	Alarm relay
** Status on relay for light	u63	Light relay
** Status on relay for valve in suction line	u64	SuctionValve
** Status on relay for compressor 2	u67	Comp2 relay
*) Not all items will be shown. Only the function belonging to the selected application can be seen.		

Fault message		Alarms
<p>In an error situation the LED's on the front will flash and the alarm relay will be activated. If you push the top button in this situation you can see the alarm report in the display. If there are more keep on pushing to see them.</p> <p>There are two kinds of error reports - it can either be an alarm occurring during the daily operation, or there may be a defect in the installation.</p> <p>A-alarms will not become visible until the set time delay has expired.</p> <p>E-alarms, on the other hand, will become visible the moment the error occurs. (An A alarm will not be visible as long as there is an active E alarm).</p> <p>Here are the messages that may appear:</p>		1 = alarm
A1: High temperature alarm		High t. alarm
A2: Low temperature alarm		Low t. alarm
A4: Door alarm		Door Alarm
A5: Information. Parameter o16 is expired		Max Hold Time
A15: Alarm. Signal from DI1 input		DI1 alarm
A16: Alarm. Signal from DI2 input		DI2 alarm
A45: Standby position (stopped refrigeration via r12 or DI input)		Standby mode
A59: Case cleaning. Signal from DI1 or DI2 input		Case cleaning
A60: High-temperature alarm for the HACCP function		HACCP alarm
		Max. def time
E1: Faults in the controller		EKC error
E6: Fault in real-time clock / reset the clock.		-
E25: Sensor error on S3		S3 error
E26: Sensor error on S4		S4 error
E27: Sensor error on S5		S5 error

Operating status	(Measurement)
The controller goes through some regulating situations where it is just waiting for the next point of the regulation. To make these “why is nothing happening” situations visible, you can see an operating status on the display. Push briefly (1s) the upper button. If there is a status code, it will be shown on the display. The individual status codes have the following meanings:	EKC State: (Shown in all menu displays)
S0: Regulating	0
S1: Waiting for end of the coordinated defrost	1
S2: When the compressor is operating it must run for at least x minutes.	2
S3: When the compressor is stopped, it must remain stopped for at least x minutes.	3
S4: The evaporator drips off and waits for the time to run out	4
S10: Refrigeration stopped by main switch. Either with r12 or a DI-input	10
S11: Refrigeration stopped by thermostat	11
S14: Defrost sequence. Defrost in progress	14
S15: Defrost sequence. Fan delay — water attaches to the evaporator	15
S17: Door is open. DI input is open	17
S20: Emergency cooling *)	20
S25: Manual control of outputs	25
S29: Case cleaning	29
S30: Forced cooling	30
S32: Delay on outputs during start-up	32
S33: Heat function r36 is active	33
<i>Other displays:</i>	
non: The defrost temperature cannot be displayed. There is stop based on time	
-d-: Defrost in progress / First cooling after defrost	
PS: Password required. Set password	

*) Emergency cooling will take effect when there is lack of signal from a defined S3 or S4 sensor. The regulation will continue with a registered average cutin frequency. There are two registered values – one for day operation and one for night operation.

Warning ! Direct start of compressors *

To prevent compressor breakdown parameter c01 and c02 should be set according to suppliers requirements or in general :

Hermetic Compressors c02 min. 5 minutes

Semihermetic Compressors c02 min. 8 minutes and c01 min. 2 to 5 minutes (Motor from 5 to 15 KW)

*) Direct activating of solenoid valves does not require settings different from factory (0)

Operation

Display

The values will be shown with three digits, and with a setting you can determine whether the temperature are to be shown in °C or in °F.

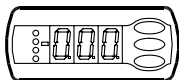

Light-emitting diodes (LED) on front panel

HACCP = HACCP function is active

The other LED's on the front panel will light up when the belonging relay is activated.

- = Refrigeration
- = Defrost
- = Fan running

The light-emitting diodes will flash when there is an alarm. In this situation you can download the error code to the display and cancel/sign for the alarm by giving the top knob a brief push.

Defrost

During defrost a -d- is shown in the display. This view will continue up till 15 min. after the cooling has resumed.

However the view of -d- will be discontinued if:

- The temperature is suitable within the 15 minutes
- The regulation is stopped with "Main Switch"
- A high temperature alarm appears

The buttons

When you want to change a setting, the upper and the lower buttons will give you a higher or lower value depending on the button you are pushing. But before you change the value, you must have access to the menu. You obtain this by pushing the upper button for a couple of seconds - you will then enter the column with parameter codes. Find the parameter code you want to change and push the middle buttons until value for the parameter is shown. When you have changed the value, save the new value by once more pushing the middle button.

Examples

Set menu

1. Push the upper button until a parameter r01 is shown
2. Push the upper or the lower button and find that parameter you want to change
3. Push the middle button until the parameter value is shown
4. Push the upper or the lower button and select the new value
5. Push the middle button again to freeze the value.

Cutout alarm relay / receipt alarm/see alarm code

- Push short the upper button
- If there are several alarm codes they are found in a rolling stack. Push the uppermost or lowermost button to scan the rolling stack.

Set temperature

1. Push the middle button until the temperature value is shown
2. Push the upper or the lower button and select the new value
3. Push the middle button again to conclude the setting.

Reading the temperature at defrost sensor

- Push short the lower button

Manuel start or stop of a defrost

- Push the lower button for four seconds.

See HACCP registration

1. Give the middle button a long push until h01 appears
2. Select required h01-h10
3. See value by giving the middle button a short push

Get a good start

With the following procedure you can start regulation very quickly:

- 1 Open parameter r12 and stop the regulation (in a new and not previously set unit, r12 will already be set to 0 which means stopped regulation.)
- 2 Select electric connection based on the drawings on page 6 to 7
- 3 Open parameter o61 and set the electric connection number in it
- 4 Now select one of the preset settings from the table on page 22.
- 5 Open parameter o62 and set the number for the array of presettings. The few selected settings will now be transferred to the menu.
- 6 Open parameter r12 and start the regulation
- 7 Go through the survey of factory settings. The values in the grey cells are changed according to your choice of settings. Make any necessary changes in the respective parameters.
- 8 For network. Set the address in o03 and start the scan function in the system manager.

HACCP

This function will follow the appliance temperature and sound an alarm if the set temperature limit is exceeded. The alarm will come when the time delay has elapsed.

When the temperature exceeds the limit value it will continuously be registered and the peak value will be saved until the later readout. Saved together with the value will be the time and duration of the temperature exceeding.

Examples of temperature exceeding:

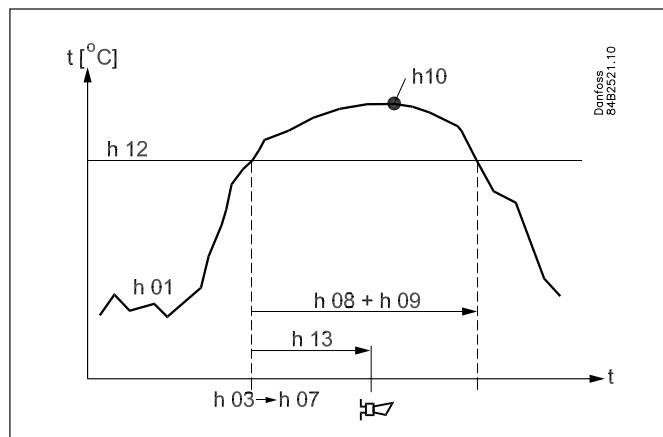

Exceeding during normal regulation

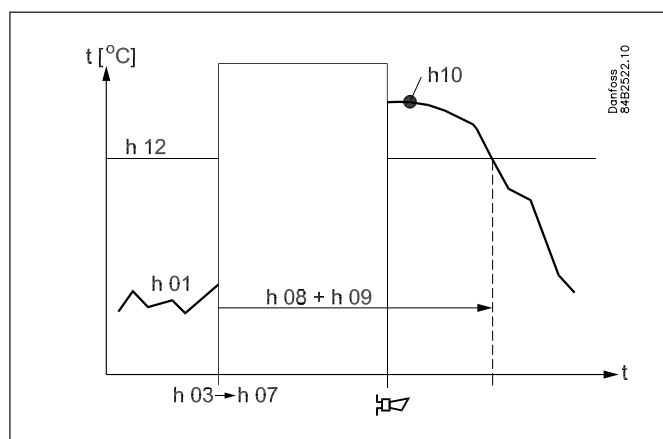

Exceeding in connection with power failure where the controller can keep on registering the time performance.

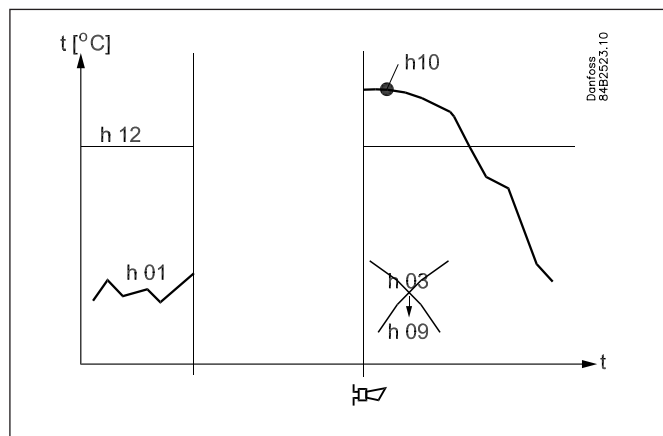

Exceeding in connection with power failure when the controller has lost its clock function and hence also its time performance.

The readout of the various values in the HACCP function can take place with a long push on the middle button.

The readouts are, as follows:

h01: The temperature

h02: Readout of the controller's status when temperature was exceeded:

H1 = normal regulation.

H2 = power failure. Times are saved.

H3 = power failure. Times not saved.

h03: Time. Year

h04: Time. Month

h05: Time. Day

h06: Time. Hour

h07: Time. Minute

h08: Duration in hours

h09: Duration in minutes

h10: The registered peak temperature

(Setup of the function takes place just like the other setups. See menu survey on the next page).

Menu survey

SW = 1.1x

Function	Parameters		EL-diagram number (page 6 to 9)										Min.-value	Max.-value	Factory setting	Actual setting		
		Codes	1	2	3	4	5	6	7	8	9	10						
Normal operation																		
Temperature (set point)		---													-50.0°C	50.0°C	2.0°C	
Thermostat																		
Differential	***	r01													0.1 K	20.0K	2.0 K	
Max. limitation of set point setting	***	r02													-49.0°C	50°C	50.0°C	
Min. limitation of set point setting	***	r03													-50.0°C	49.0°C	-50.0°C	
Adjustment of temperature indication		r04													-20.0 K	20.0 K	0.0 K	
Temperature unit (°C/°F)		r05													°C	°F	°C	
Correction of the signal from S4		r09													-10.0 K	+10.0 K	0.0 K	
Correction of the signal from S3		r10													-10.0 K	+10.0 K	0.0 K	
Manual service, stop regulation, start regulation (-1, 0, 1)		r12													-1	1	0	
Displacement of reference during night operation		r13													-10.0 K	10.0 K	0.0 K	
Definition and weighting, if applicable, of thermostat sensors - S4% (100%=S4, 0%=S3)		r15													0%	100%	100%	
The heating function is started a number of degrees below the thermostats cutout temperature		r36													-15.0 K	-3.0 K	-15.0 K	
Activation of reference displacement r40		r39													OFF	ON	OFF	
Value of reference displacement (activate via r39 or DI)		r40													-50.0 K	50.0 K	0.0 K	
Alarm																		
Delay for temperature alarm		A03													0 min	240 min	30 min	
Delay for door alarm	***	A04													0 min	240 min	60 min	
Delay for temperature alarm after defrost		A12													0 min	240 min	90 min	
High alarm limit	***	A13													-50.0°C	50.0°C	8.0°C	
Low alarm limit	***	A14													-50.0°C	50.0°C	-30.0°C	
Alarm delay DI1		A27													0 min	240 min	30 min	
Alarm delay DI2		A28													0 min	240 min	30 min	
Signal for alarm thermostat. S4% (100%=S4, 0%=S3)		A36													0%	100%	100%	
Compressor																		
Min. ON-time		c01													0 min	30 min	0 min	
Min. OFF-time		c02													0 min	30 min	0 min	
Time delay for cutin of comp.2		c05													0 sec	999 sec	0 sec	
Compressor relay 1 must cutin and out inversely (NC-function)		c30													0	1	0	
External relays (zero-crossing control) Must be 'ON' when connecting to external relays		c70													OFF	ON	OFF	
Defrost																		
Defrost method (none/EL/GAS/BRINE)		d01													no	bri	EL	
Defrost stop temperature		d02													0.0°C	25.0°C	6.0°C	
Interval between defrost starts		d03													0 hours	48 hours	8 hours	
Max. defrost duration		d04													0 min	180 min	45 min	
Displacement of time on cutin of defrost at start-up		d05													0 min	240 min	0 min	
Drip off time		d06													0 min	60 min	0 min	
Delay for fan start after defrost		d07													0 min	60 min	0 min	
Fan start temperature		d08													-15.0°C	0.0°C	-5.0°C	
Fan cutin during defrost 0: Stopped 1: Running 2: Running during pump down and defrost		d09													0	2	1	
Defrost sensor (0=time, 1=S5, 2=S4)		d10													0	2	0	
Pump down delay		d16													0 min	60 min	0 min	
Drain delay		d17													0 min	60 min	0 min	
Max. aggregate refrigeration time between two defrosts		d18													0 hours	48 hours	0 hours	
Defrost on demand - S5 temperature's permitted variation during frost build-up. On central plant choose 20 K (=off)		d19													0.0 K	20.0 k	20.0 K	
Delay of hot gas defrost		d23													0 min	60 min	0 min	
Fan																		
Fan stop at cutout compressor		F01													no	yes	no	
Delay of fan stop		F02													0 min	30 min	0 min	
Fan stop temperature (S5)		F04													-50.0°C	50.0°C	50.0°C	
HACCP																		
Actual temperature measurement for the HACCP function		h01																
Last registered peak temperature		h10																
Selection of function and sensor for the HACCP function. 0 = no HACCP function. 1 = S4 used (maybe also S3). 2 = S5 used		h11													0	2	0	
Alarm limit for the HACCP function		h12													-50.0°C	50.0°C	8.0°C	
Time delay for the HACCP alarm		h13													0 min.	240 min.	30 min.	
Select signal for the HACCP function. S4% (100% = S4, 0% = S3)		h14													0%	100%	100%	
Real time clock																		
Six start times for defrost. Setting of hours. 0=OFF		t01-t06													0 hours	23 hours	0 hours	
Six start times for defrost. Setting of minutes. 0=OFF		t11-t16													0 min	59 min	0 min	
Clock - Setting of hours	***	t07													0 hours	23 hours	0 hours	
Clock - Setting of minute	***	t08													0 min	59 min	0 min	
Clock - Setting of date	***	t45													1	31	1	
Clock - Setting of month	***	t46													1	12	1	
Clock - Setting of year	***	t47													0	99	0	

		1	2	3	4	5	6	7	8	9	10				
Miscellaneous															
Delay of output signals after start-up		o01											0 s	600 s	5 s
Input signal on DI1. Function: 0=not used. 1=status on DI1. 2=door function with alarm when open. 3=door alarm when open. 4=defrost start (pulse-signal). 5=ext.main switch. 6=night operation 7=change reference (activate r40). 8=alarm function when closed. 9=alarm function when open. 10=case cleaning (pulse signal). 11=forced cooling at hot gas defrost.		o02											1	11	0
Network address (0 =off)		o03											0	240	0
On/Off switch (Service Pin message) IMPORTANT! o61 must be set prior to o04		o04											OFF	ON	OFF
Access code 1 (all settings)		o05											0	100	0
Used sensor type (Pt /PTC/NTC)		o06											Pt	ntc	Pt
Display step = 0.5 (normal 0.1 at Pt sensor)		o15											no	yes	no
Max hold time after coordinated defrost		o16											0 min	60 min	20
Select signal for display view. S4% (100%=S4, 0%=S3)		o17											0%	100%	100%
Input signal on DI2. Function: (0=not used. 1=status on DI2. 2=door function with alarm when open. 3=door alarm when open. 4=defrost start (pulse-signal). 5=ext. main switch 6=night operation 7=change reference (activate r40). 8=alarm function when closed. 9=alarm function when open. 10=case cleaning (pulse signal). 11=forced cooling at hot gas defrost.). 12=coordinated defrost)		o37											0	12	0
Configuration of light function (relay 4) 1=ON during day operation. 2=ON / OFF via data communication. 3=ON follows the DI-function, when DI is selected to door function or to door alarm		o38											1	3	1
Activation of light relay (only if o38=2)		o39											OFF	ON	OFF
Rail heat On time during day operations		o41											0%	100%	100
Rail heat On time during night operations		o42											0%	100%	100
Rail heat period time (On time + Off time)		o43											6 min	60 min	10 min
Case cleaning. 0=no case cleaning. 1=Fans only. 2=All output Off.	***	o46											0	2	0
Selection of EL diagram. See overview page 6-7	*	o61											1	10	1
Download a set of predetermined settings. See overview next page.	*	o62											0	6	0
Access code 2 (partly access)	***	o64											0	100	0
Replace the controllers factory settings with the present settings		o67											OFF	On	OFF
Service															
Status codes are shown on page 17		S0-S33													
Temperature measured with S5 sensor	***	u09													
Status on DI1 input. on/1=closed		u10													
Temperature measured with S3 sensor	***	u12													
Status on night operation (on or off) 1=closed	***	u13													
Temperature measured with S4 sensor	***	u16													
Thermostat temperature		u17													
Read the present regulation reference		u28													
Status on DI2 output. on/1=closed		u37													
Temperature shown on display		u56													
Measured temperature for alarm thermostat		u57													
Status on relay for cooling	**	u58													
Status on relay for fan	**	u59													
Status on relay for defrost	**	u60													
Status on relay for railheat	**	u61													
Status on relay for alarm	**	u62													
Status on relay for light	**	u63													
Status on relay for valve in suction line	**	u64													
Status on relay for compressor 2	**	u67													

- * Can only be set when regulation is stopped (r12=0)
- ** Can be controlled manually, but only when r12=-1
- *** With access code 2 the access to these menus will be limited

Factory setting

If you need to return to the factory-set values, it can be done in this way:

- Cut out the supply voltage to the controller
- Keep both buttons depressed at the same time as you reconnect the supply voltage



Auxiliary table for settings (quick-setup)	Case			Room		
	Defrost stop on time	Defrost stop on S5		Defrost stop on time	Defrost stop on S5	
Preset settings (o62)	1	2	3	4	5	6
Temperature (SP)	4°C	2°C	-24°C	6°C	3°C	-22°C
Max. temp. setting (r02)	6°C	4°C	-22°C	8°C	5°C	-20°C
Min. temp. setting (r03)	2°C	0°C	-26°C	4°C	1°C	-24°C
Sensor signal for thermostat. S4% (r15)	100%			0%		
Alarm limit high (A13)	10°C	8°C	-15°C	10°C	8°C	-15°C
Alarm limit low (A14)	-5°C	-5°C	-30°C	0°C	0°C	-30°C
Sensor signal for alarm funct.S4% (A36)	100%			0%		
Interval between defrost (d03)	6 h	6h	12h	8h	8h	12h
Defrost sensor: 0=time, 1=S5, 2=S4 (d10)	0	1	1	0	1	1
DI1 config. (o02)	Case cleaning (=10)			Door function (=3)		
Sensor signal for display view S4% (017)	100%			0%		

Override

The controller contains a number of functions that can be used together with the override function in the System Manager.

Function via data communication	Functions to be used in the system manager's override function	Used parameter in AK-CC 350
Start of defrosting	Defrost control Time schedule	--- Def.start
Coordinated defrost	Defrost control	--- HoldAfterDef --- Defrost state
Night setback	Day/night control Time schedule	--- Night setbck
Light control	Day/night control Time schedule	o39 Light Remote

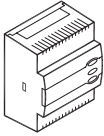
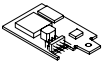
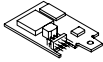
Ordering

Type		Function	Code no.
AK-CC 350		Refrigeration controller with MODBUS data communication	084B4165
EKA 175		Data communication module LON RS485	084B8579
EKA 178B		Data communication module MODBUS	084B8571
EKA 163A		External display option	084B8562
EKA 164A		External operation option	084B8563

Type		Function	Code no.
EKA 183A		Programming key	084B8582
Copy tool for setting of AK-CC. For further details refer to Technical Brochure RD8BJ			

Connections

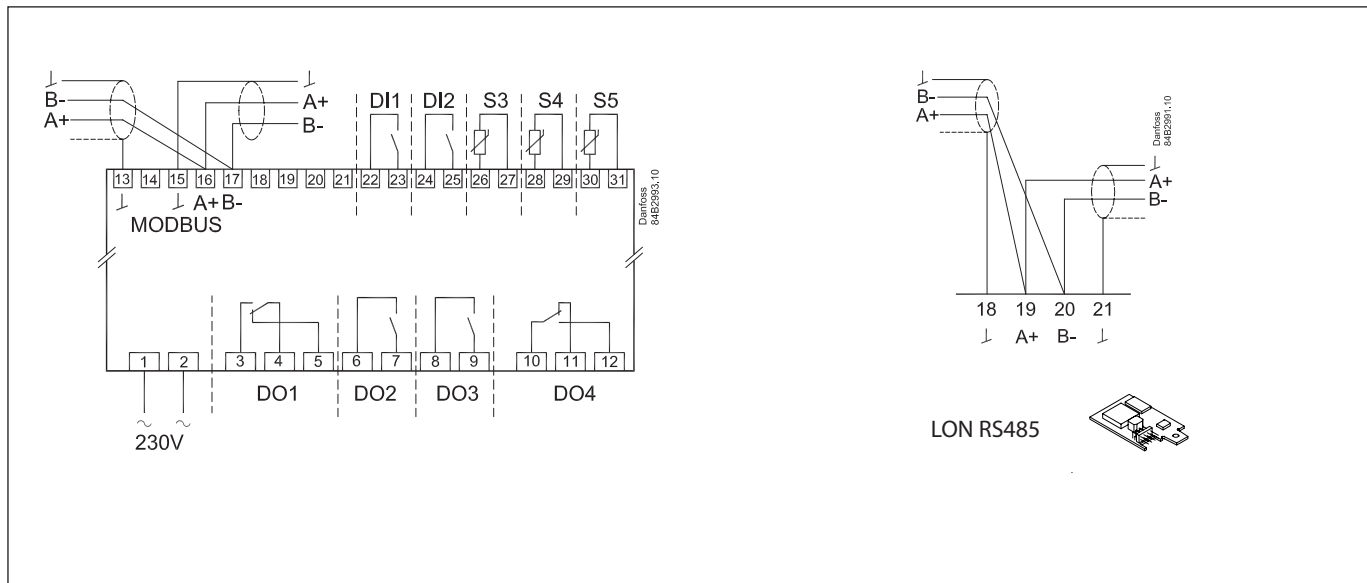

Power supply

230 V a.c.

Sensors

S3 and S4 are thermostat sensors.

A setting determines whether S3 or S4 or both of them are to be used.

S5 is a defrost sensor and is used if defrost has to be stopped based on temperature.

Digital On/Off signals

A cut-in input will activate a function. The possible functions are described in menus o02 and o37.

External display

You can connect an external display. The display is connected MODBUS input. See next page.

Relays

The general uses are mentioned here. See also page 6 to 7 where the different applications are shown.

DO1: Refrigeration. The relay will cut in when the controller demands refrigeration

DO2: Defrost. The relay will cut in when defrost is in progress

DO3: For either fans or refrigeration 2

Fans: The relay will cut in when the fans have to operate

Refrigeration 2: The relay will cut in when refrigeration step 2 has to be cut in

DO4: For either alarm, rail heat, light or hot gas defrost

Alarm: Cf. diagram. The relay is cut in during normal operation and cuts out in alarm situations and when the controller is dead (de-energised)

Rail heat: The relay cuts in when rail heat is to operate

Light: The relay cuts in when the light has to be switched on

Hot gas defrost: See diagram. The relay will cut out when defrost has to be done

Data communication

Fixed MOD-bus.

If data communication is used, it is important that the installation of the data communication cable is performed correctly.

See separate literature No. RC8AC...

AK-CC 350 can also use LON RS 485, but this requires a data communication module type EKA 175. The connections must be made to terminals 18 to 21.

Electric noise

Cables for sensors, DI inputs and data communication **must** be kept separate from other electric cables:

- Use separate cable trays
- Keep a distance between cables of at least 10 cm
- Long cables at the DI input should be avoided

Coordinated defrost via cable connections

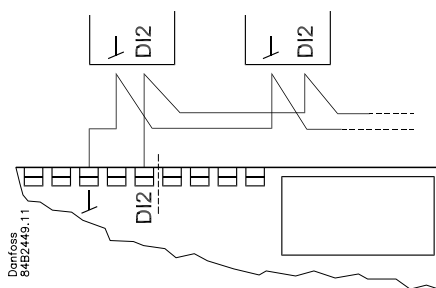

The following controllers can be connected up in this way:
 EKC 202D, EKC 302D, AK-CC 210, AK-CC 250, AK-CC 350, AK-CC 450, AK-CC 550
 (However max. 10)

Refrigeration is resumed when all controllers have "released" the signal for defrost.

Coordinated defrost via data communication

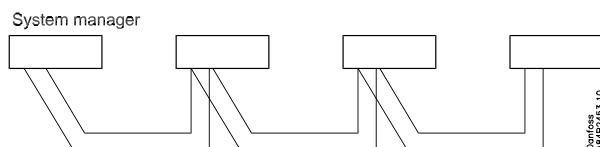

External display

Only in standalone

Do not connect anything other than a display on data communication. The distance to the display must not exceed 200 m.

An address has to be set in o03 (0 can not be used). The display will self find the controller address.

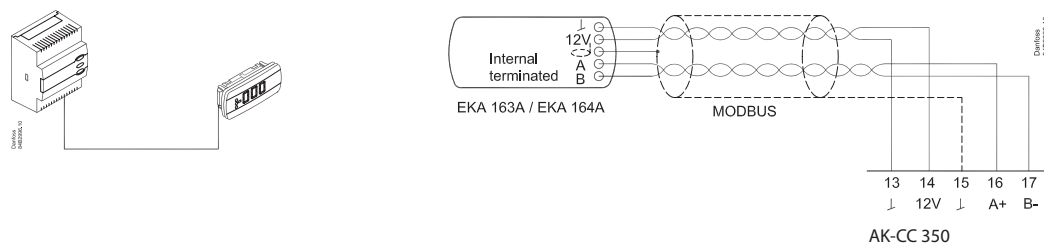

External display and AK-CC 350 plus data communication

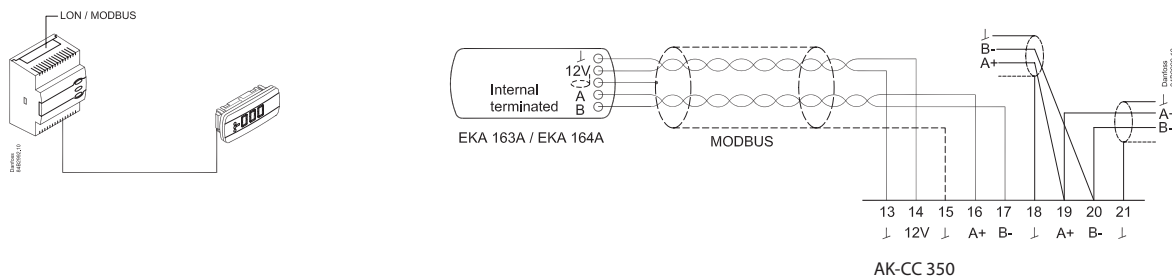

+ EKA 175 (LON RS485)

+ EKA 178B (MODBUS)

Data

Supply voltage	230 V a.c. +10/-15 %. 2.5 VA, 50/60 Hz		
Sensors 3 pcs off either	Pt 1000 or PTC (1000 ohm) or NTC-M2020 (5000 ohm / 25°C)		
Accuracy	Measuring range	-60 to +99°C	
	Controller	±1 K below -35°C ±0.5 K between -35 to +25°C ±1 K above +25°C	
	Pt 1000 sensor	±0.3 K at 0°C ±0.005 K per grad	
Display	LED, 3-digits		
External display	EKA 163A / EKA 164A		
Digital inputs	Signal from contact functions Requirements to contacts: Gold plating Cable length must be max. 15 m Use auxiliary relays when the cable is longer		
Electrical connection cable	Max. 1,5 mm ² multi-core cable Max. 1 mm ² on sensors and DI inputs		
Relays*	IEC60730		
	DO1	10 (6) A & (5 FLA, 30 LRA)	1)
		16 (8) A & (10 FLA, 60 LRA)	2)
	DO2	6 (3) A & (3 FLA, 18 LRA)	1)
		10 (6) A & (5 FLA, 30 LRA)	2)
	DO3	6 (3) A & (3 FLA, 18 LRA)	1)
10 (6) A & (5 FLA, 30 LRA)		2)	
DO4**	4 (1)A Min. 100 mA**		
Data communication	MODBUS AK-CC 350 can be expanded with LON or MODBUS		
Environments	0 to +55°C, During operations		
	-40 to +70°C, During transport		
	20 - 80% Rh, not condensed		
Enclosure	IP 20		
Escapement reserve for the clock	4 hours		
Approvals	EU Low Voltage Directive and EMC demands re CE-marking complied with LVD tested acc. EN 60730-1 and EN 60730-2-9, A1, A2 EMC tested acc. EN 61000-6-3 and EN 61000-6-2		

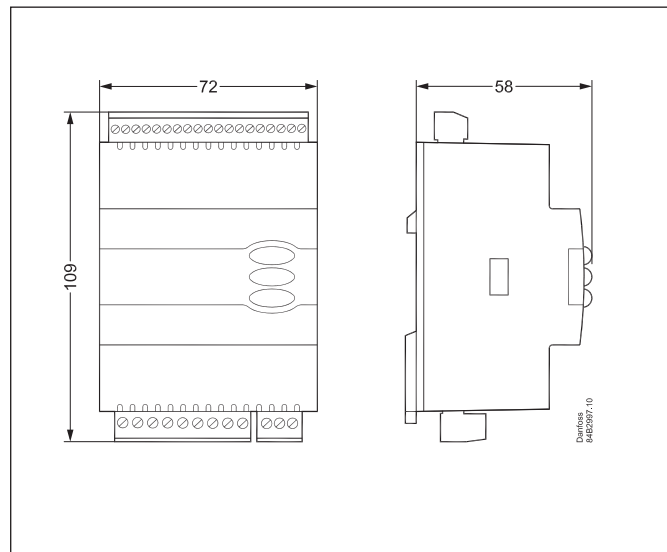

* DO1 is 20 A relay, DO2 and DO3 are 16 A relays, DO4 is a 10 A relay. The max. load listed above must be observed when connecting without zero-crossing control. When connecting with zero-crossing control, the load must be increased to the value indicated by 2)

** Gold plating ensures make function with small contact loads

1) With external relay (c70=ON) (zero-crossing control disabled)

2) Without external relay (c70=OFF) (zero-crossing control enabled)

Relay contact and controller supply **must** use same phase and the load (compressor) must phase compensated to $\cos \varphi = 1$.

Capacitive load

The relays cannot be used for the direct connection of capacitive loads such as LEDs and on/off control of EC motors.

All loads with a switch mode power supply must be connected with a suitable contactor or similar.