

User Guide

Stepper Valve Extension Module Type EKE 1P

ADAP-KOOL® Refrigeration Control System



Contents

Introduction	3
Application 1	4
Application 2	4
User Interface.....	5
End-user overview with graphical display	7
Service and commissioning with graphical display	7
Menu	8
Alarm list.....	11
ERR31	12
Connections	13
Technical Data	14
Installation considerations.....	14
Mounting/dimensions.....	15
Ordering	15

Introduction

Application

The controller is used as an extension module for other Danfoss controllers (application 1 below) or as a stepper valve driver (application 2 below).

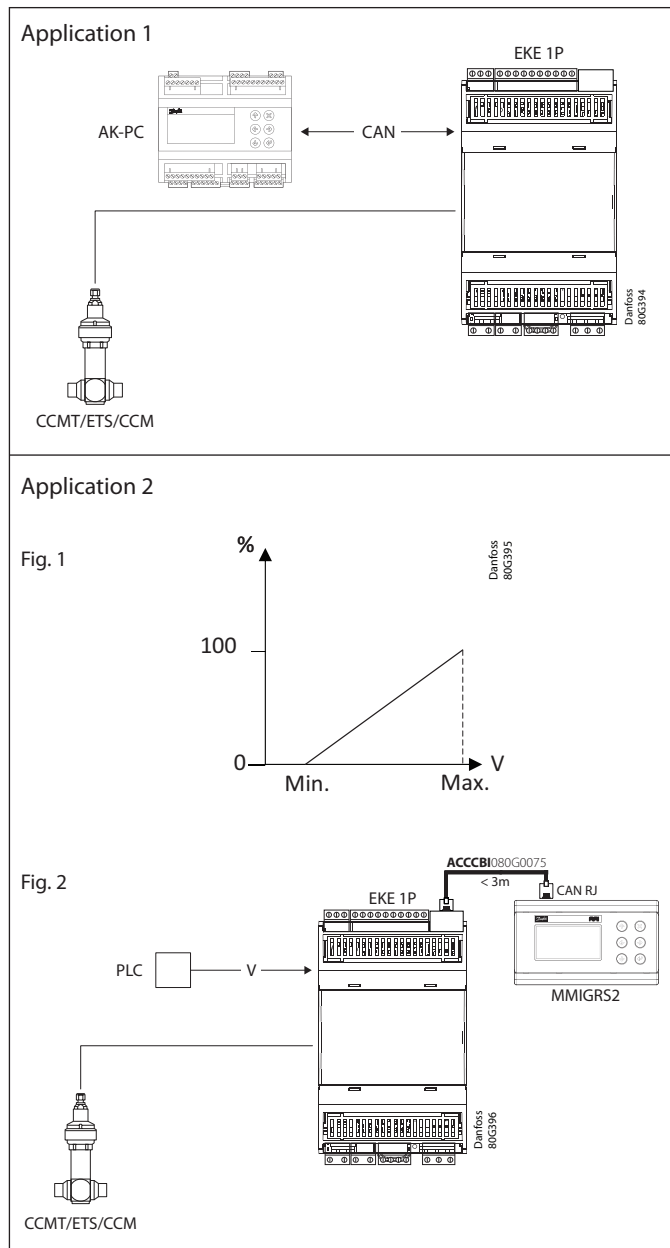

Advantages

- Simplified settings:
 - For application 1, typically the controller needs no parameter adjustment
 - For application 2, only a few key parameter settings may be required
- Power Supply:
 - Easy wiring layout. With no risk of causing short circuits when connecting to other units through power supply
 - 24 V AC or 24 V DC: flexibility in selecting different transformers
- Universal valve support:
 - Drives bipolar and unipolar valves
 - Danfoss standard valves selectable through drop-down
 - Flexible configuration of valve driver parameters for non-Danfoss standard valves

Input and output

In application mode 1, all input and output are defined via the master controller AK-PC set-up.

In application mode 2, the input and output are intended for one specific function.

The overview of connections can be seen on page 12.

Operation

The daily operation can be set up via an external display device although this is normally not required for application 2.

The normal operation screen for application 1 is shown below. During set-up, the display images will be adjusted so that only the relevant images are opened for additional setting and end-user operation.

The operation is password protected, and three levels of access can be granted.

The controller contains English language only.

Two sets of LEDs on the EKE 1P indicate the EKE 1P application confirmation, valve status and alarm condition – see details further below.

Data communication

The controller has a built-in CANBUS and a built-in MODBUS interface. The interfaces are used as shown in below table:

	CANBUS	MODBUS
Application 1	Interface to master controller, AK-PC	MODBUS master for establishing communication with other MODBUS devices to the master controller, AK-PC
Application 2	Configuration of EKE 1P and daily use interface	Not used – must not be connected to any MODBUS network

Fail-safe valve closure

As a stepper valve is provided with step motor, it will remain open in a power failure situation.

For safety reasons, the liquid flow through the stepper valve must be cut off if a power failure occurs.

There are two ways of coping with this situation.

One of the following two solutions can be applied in the system:

- Mounting of a solenoid valve in front of EEV
- Connection of a battery back-up for EEV valve

If the battery back-up is used, the battery voltage may be continuously monitored to generate an alarm in case the battery voltage gets out of range. As default this alarm is disabled.

Application 1

Application mode

In application 1, the EKE 1P operates as an extension module to a CO₂ pack controller, AK-PC. It is possible to configure if the EKE 1P is used as an extension module where the stepper output controls the high pressure, or as an extension module where the stepper output controls the receiver pressure.

This is configurable through a software setting (parameter “Mode”) or through a hardware configuration. As default the hardware configuration is enabled, which means the AI4 input is used for the configuration as follows:

AI4 open circuit or connected to 0 V (COM): high-pressure valve driver
AI4 connected to 5 V+: receiver valve driver

The IO configuration of application 1 is determined through the configuration of the AK-PC.

Some, all or a sub-set of the inputs and outputs may be used. See documentation of the specific AK-PC for details.

Valve configuration

In application mode 1, the valve type is configured via the AK-PC. Only if the valve type is set to “User Defined” in the AK-PC, it is required to access the EKE 1P parameter list for configuring the valve specific parameters like number of steps, max current etc.

In application mode 1, the EKE 1P will set the valve opening degree to a fixed value in case of losing the CANBUS communication to the AK-PC. As default the valve will close in this case.

Application 2

Valve configuration

The valve type can be selected from an extensive list of Danfoss standard valve types. When a standard type is selected, only a few parameters need to be set i.e. a valve neutral zone, the valve overdrive and valve opening degree in special situations. If Danfoss standard valve type is not selected, app. 20 parameters for the valve and valve motor control become visible (“Valve motor type”, “Valve drive current” etc.). See “Menu” for details.

Analogue input scaling

The EKE 1P may be configured for various voltage ranges, e.g. 2 – 10 V. Here the valve will be 0% open at 0 V and 100% open at 10 V and proportionally opened in values between. Typical input ranges may be configured or the voltage range may be freely configured within 0 – 10 V and 10 – 0 V.

Note: if the minimum is set to 0 V, the valve will start opening at 0.1 V to ensure detection of a valve closure signal (0 V).

Valve neutral Zone

The EKE 1P controller has a complex algorithm implemented to handle oscillation issues related to output valve OD by defining some neutral zone. In neutral zone, the valve will not move until it overcomes the definite variation in the valve opening degree.

Valve Overdrive

To compensate for lost steps, the valve may be overdriven when it closes to 0%. i.e. it will close with extra steps to make sure that it is fully closed. This may, however, lead to increased wear on the valve if it occurs frequently. To prevent this, the overdrive will only be enabled when the valve opening degree exceeds a set value and the overdrive function may only re-occur within a set interval.

User Interface

LED alarm and status indication

LED indication:

Two sets of Light Emitting Diodes make it possible to follow the operation status of the valve and the controller.

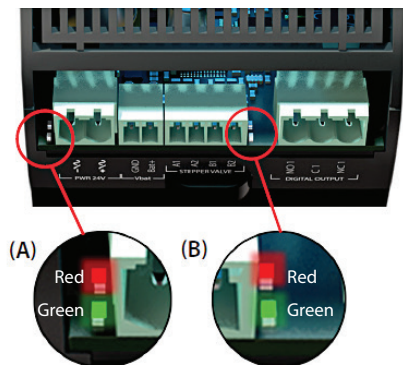

LED A: Two status LEDs indicate power and controller operation

Power-up:

1. AI valve driver module		Configured as AI controlled stepper valve - will blink for 30 sec. after power-up.
2. HP module		Configured as HP module - will blink for 30 sec. after power-up.
3. Receiver module		Configured as receiver module - will blink for 30 sec. after power-up.
		Hardware problem.

Normal operation:

4. Power		Pattern during normal operation.
5. MODBUS error power		Pattern during normal operation, but MODBUS error.
6. Power main switch OFF		Pattern during normal operation, main switch = OFF.
		Hardware problem.

R = Red
G = Green

LED B: Two status LEDs to indicate valve operation

V1. Valve closed		Steady red = valve fully closed.
V2. Valve closing		Flashing red (2 Hz) = valve closing.
V3. Valve idle		Running on target. Both Red and Green off.
V4. Valve opening		Flashing green (2 Hz) = valve opening.
V5. Valve open		Steady green = valve fully open.

R = Red

G = Green

End-user overview with graphical display

The first screen in this daily user interface shows the status of the relevant inputs and outputs and will depend on how the set-up is made (application mode).

Click on the "▶" to view e.g. the following images:

Application 1 – High pressure:



Application 1 – Receiver pressure:



Application 2:



Service and commissioning with graphical display

To access the parameter menu, press and hold the "Enter" button for 3 seconds while the first screen in the daily user view (showing input and output values) is displayed.

See next section for details.

Menu

Start/Stop			
Main switch	Main switch Start and stop regulating here. The configuration settings will require that regulating is stopped. If you try to enter a configuration setting when regulating has started, the controller will ask if regulating should be stopped. When all settings have been made and the main switch is set to "ON", the controller will enable the display of the various measurements. Regulation will start. (One external main switch must be "ON" before regulation starts.) Note: In application 1, the main switch automatically follows the main switch of the AK-PC.		On / Off Fac: Off
Device config			
Mode	Selection of the application mode and how the device is used in application 1. Note: changing this setting also changes the EKE 1P address, causing communication with the graphical display to stop. Communication will resume after a power cycle. AI HP/Rec.: Appl. 1 - selection by AI4 HP exp: Appl. 1 - High Pressure expansion module Rec. exp.: Appl. 1 - Receiver Expansion module AI valve: Appl. 2 - Valve Driver		AI HP/Rec. / HP exp / Rec. exp. / AI valve Fac: AI HP/Rec.
AI valve input scale	Configuration of the Analogue Input in application mode 2. If user defined is selected, the scaling is created via the two parameters, "AI 0% OD" and "AI 100% OD" which become visible.		0 – 5 V / 1 – 5 V / 0 – 10 V / 2 – 10 V / 5 – 0 V / 5 – 1 V / 10 – 0 V / 10 – 2 V / User Defined Fac: 0 - 10V
System			
Display	Login time-out	If buttons have not been pressed within a specified period of time, the screen will return to the overview display. Afterwards, the user will have to log on again. If the time is changed, the new time will apply the next time the user logs in. If you log out here without waiting for the time-out period to elapse, go to the overview display and hold down the "X" button for 3 seconds.	Min: 1 min. Max: 60 min. Fac: 2 min.
	Display unit	Temperature and Pressure unit	Metric (°C & bar) / Imperial (°F & psig) Fac: Metric (°C & bar)
	Backlight time-out	If no buttons have been pushed for a specific period of time, the light in the display will be minimised. The light level will be restored upon renewed activity.	Min: 1 min. Max: 60 min. Fac: 1 min.
Password	The settings in the controller can be protected with three levels of access codes. The three access codes are numbers between 001 and 999.		
	Password daily	Level 1: End user settings, such as changing the main switch	Fac: 100
	Password service	Level 2: Adjusting installer level	Fac: 200
	Password commission	Level 3: Configuration of system settings (configuration menu)	Fac: 300
Reset to Factory	Apply defaults	This will reset the controller back to default (factory) settings	On / Off Fac: Off
I/O			
Input status	AI 1 ... AI 4	Here you can see pressure and temperature values received by the analogue inputs. The values include calibration	
	DI 1 ... DI2	Here you can see the status of the digital input function/alarm	
Output	Relay state	Here you can see if the function is on or off	
	Relay control	Manual control of relay in application 2. In application 1 the manual control is done from the AK-PC controller. Under normal regulation, the function of the relay will be in "Auto". In the event of an override, the function will be switched to either "On" or "Off". Remember to switch to "Auto" when the override is to be completed. Otherwise it will remain in override until the device is power cycled or reset to factory settings	Auto / On / Off Fac: Auto
Configure	DI1 Active at ... DI2 Active at	Define whether the function/alarm will be active with terminals short-circuited (ON) or open-circuited (OFF)	On / Off Fac: On
Alarm config			
Battery alarm	If a battery back-up is connected to EKE 1P terminals, the EKE 1P will close the stepper motor if the controller loses its supply voltage. The battery voltage must not be connected from main power supply connected to EKE 1P. A battery voltage lower than 16.5 V will trigger the battery alarm. The battery back-up may be the Danfoss module (EKE 2U) or a general type (Bat.).		No / Bat. / EKE2U Fac: No

Valve config		
	Any changes made to parameters in this group will only take effect after a restart of the controller, e.g. by a power cycle or by toggling the main switch.	
Valve configuration	<p>Application 1: Set from AK-PC except if the valve type is set to User Defined in AK-PC, then it is according to below list (see Application mode 2).</p> <p>Application 2:</p> <p>0 = no valve, 1 = UserDef, 2 = ETS 12C, 3 = ETS 24C, 4 = ETS 25C, 5 = ETS 50C, 6 = ETS 100C, 7 = ETS 6, 8 = ETS 12.5, 9 = ETS 25, 10 = ETS 50, 11 = ETS 100, 12 = ETS 250, 13 = ETS 400, 14 = KVS 2C, 15 = KVS 3C, 16 = KVS 5C, 17 = KVS 15, 18 = KVS 42, 19 = CCMT 0, 20 = CCMT 1, 21 = CCMT 2, 22 = CCMT 4, 23 = CCMT 8, 24 = CCMT 16, 25 = CCMT 24, 26 = CCMT 30, 27 = CCMT 42, 28 = CCM 10, 29 = CCM 20, 30 = CCM 30, 31 = CCM 40, 32 = CTR 20 33 = CCMT 3L, 34 = CCMT 5L, 35 = CCMT 8L</p>	Fac: no valve
Valve fallback OD	During fail-safe mode in application 1 (e.g. CANBUS signal lost), the valve will apply this opening degree.	0 – 100% Fac: 0%
Valve motor type	Define a type of motor used in the stepper valve (Unipolar/Bipolar).	Unipolar / Bipolar Fac: Unipolar
Valve drive current	The current applied to each phase of the stepper motor during actual valve movement. Entered as a peak value.	10 – 1000 mA Fac: 10 mA
Valve step positioning	Read-out of the valve opening degree in number of steps.	
Valve total steps	The number of steps that correspond to changing the valve position from 0 – 100% OD.	1 – 8000 steps Fac: 1 step
Valve speed	The desired valve drive rate in steps per second. Please note that a higher valve speed will produce a lower torque. If the valve is used in systems having high differential pressure, it is better to operate the valve with a lower step rate.	10 – 400 pps Fac: 10 pps
Valve start speed	This is used to limit the starting speed of the valve in order to provide higher motor torque at start-up to prevent the valve from potential step loss.	1 – 100% Fac: 20%
Valve emergency speed	During power failure conditions, the valve can be driven at higher speed when required to close faster. This function requires a back-up battery connected to the EKE.	50 – 200% Fac: 100%
Valve acceleration current	These features are used with valves running at higher speed i.e 300 pps and above. Typically, at start-up high torque is required to operate the valve. The high torque at start-up can be maintained by using acceleration current as required.	100 – 150% Fac: 100%
Valve acceleration time		10 – 150 ms Fac: 10 ms
Valve holding current	The percent of the programmed Max Phase Current that should be applied to each phase of the stepper output when the valve is stationary. If required, this current ensures that the valve maintains its last programmed position.	0 – 300% Fac: 0
Valve step mode	Stepper motor can be driven with various step excitation methods, depending on valve requirements and operating conditions. The valves can be driven in full step 1/1, half step 1/2, or in microsteps (1/4, 1/8, 1/16).	Full, Half, 1/4, 1/8, 1/16 Fac: 1/8
Valve duty cycle	The required valve duty cycle can be set between 5-100% using this parameter.	5 – 100% Fac: 100%
Valve OD during stop	The valve will apply this opening degree if the control is stopped (main switch off).	0 – 100% Fac: 0%
Start backlash	The parameter defines the operation of the start backlash function. The valve will normally open from this point onwards.	0 – 50% Fac: 0.0%
Compensation backlash	This setting is used to correct for mechanical hysteresis of the valve's designs including a reduction gear. To ensure that the gear backlash is at a minimum, the motor will drive a number of extra steps every time the direction of the motor is changed.	0-10% Fac: 0.0%
Overdrive	When the overdrive is enabled and the block timer has expired, next time the valve closes to 0% OD, it will close with some extra steps according to this setting.	0 – 20% Fac: 5.0%
Overdrive enable OD	After being closed, the valve opening degree must exceed this value before the overdrive function is enabled again.	0 – 100% Fac: 0%
Overdrive block time	After an overdrive has occurred, the overdrive function may not occur again within this time.	0 – 1440 min. Fac: 10 min.
Valve excitation time after stop	The time that the drive current is applied after the motor has stopped before going to holding current. This will make sure that the valve has achieved the final position before going to holding current.	0 – 1000 ms Fac: 10 ms

Valve neutral zone	An EKE controller has a complex algorithm implemented to handle oscillation issues related to output valve OD by defining some neutral zone. In neutral zone, the valve will not move until it overcomes the definite variation in the valve opening degree. For the default neutral zone of 0.5 % hysteresis, the valve will not move if it is unable to receive the higher variation than the set value. The benefit of using such techniques will not affect the performance of the system, but will reduce the problem related with the fluctuating signal, step loss and hysteresis in the valve.	0 – 5% Fac: 0.5%
Communication		
Controller adr.	Controller address - applies both to the MODBUS and the CANBUS	
CAN baudrate	Setting of the CANBUS baudrate	20k / 50k / 125k / 250k / 500k / 1M Fac: 50k
Service		
Actual OD	Read-out of the valve opening degree in percentage	
Actual step	Read-out of the valve opening degree in number of steps	
EKE 2U state	Read-out of the EKE 2U battery back-up module status. Init: Initialising Ready: Fully charged and functional Char: Charging Repl: Check connections or replace EKE 2U module as the battery voltage is likely too low to guarantee full closure of the valves. Fault: EKE 2U battery voltage too low to close the valve.	
Actual battery voltage	Read-out of the battery back-up voltage level	
Manual mode	Enables manual control of the valve. Remember to disable this function after manual control. Otherwise the EKE 1P will remain in manual mode until a power cycle or main switch occurs.	On / Off Fac: Off
Manual OD	Manual control of the valve opening degree in application 2. In application 1 the manual control is done from the AK-PC. When entering the manual mode, the valve will start at the current OD.	0 – 100% Fac: current OD

Alarm list

Alarm text	Description
Valve configuration error	One or more valve configuration errors are blocking operation of stepper valve. Check the other active alarms to identify the valve configuration problem.
No valve configured	No valve selected. Please configure the correct valve.
Battery critical low voltage	Voltage from back-up module is found to be critically low and the valve will likely not be fully closed in case of a power failure. Check connections / replace battery or EKE 2U module.
Battery low voltage	Voltage from back-up module is found to be too low to close the valve in case of power failure. Replace battery or EKE 2U module.
Standby mode	The controller is in standby due to the Main switch parameter setting being off.
Manual control	The controller is in manual control, no automatic control is active and many alarms are disabled.
Check valve step mode vs positioning	With I064 Valve step mode set to "full" and I029 Valve step positioning set, Half step operation is possible. Correct either I029 or I064.
Valve speed too fast	Number of micro steps/sec is too high (higher than 12800 micro step/sec): Reduce valve speed or use less micro steps per full step.
Valve speed too slow	Number of micro steps/sec is low (lower than 8 micro step/sec), increase valve speed, increase valve start speed or use more micro steps per full step.
Valve emergency speed too fast	Number of micro steps/sec is too high (higher than 12800 micro step/sec). Reduce valve emergency speed.
Valve emergency speed too slow	Number of micro steps/sec is low (lower than 8 micro step/sec). Increase valve emergency speed.
Valve start speed too slow	Number of micro steps/sec is low (lower than 8 micro step/sec). Increase valve speed, increase valve start speed or use more micro steps per full step.
Valve short circuit or driver too hot	Valve driver is unable to drive valve. Check for short circuit of the coils or if ambient is higher than 60 °C.
Low supply voltage	Supply voltage is found to be lower than expected tolerance.
Network master missing (CAN)	No communication possible with the pack controller AK-PC in application 1. Check the CANBUS connection and configuration in both EKE 1P and AK-PC.
ERR31	See next page

ERR31

Alarm on the external display - MMIGRS2

If the communication to the display is not carried out correctly, it will send an "ERR31" error notification.

This may be caused by the displayed wires H to R not being installed, or that there have been interruptions in data communication during the time when the display retrieves the basic information from the controller.

Once the terminations have been inspected, you should then check the software version of the external display. This is done by holding down the Enter key and the X key for 5 seconds, until the Bios menu appears.

Next, press the X key and read off the software version in the bottom right corner. The software version must be 1.13 or newer.

Once the display's software version has been checked, check the display's settings as follows:

1. Hold the Enter key and the X key down for 5 seconds, until the Bios menu appears.
2. Select the "MCX selection" menu
 - Select the "Clear UI" line and press Enter
 - Select the "Autodetect" line and press Enter
3. Press the X key to return to the Bios menu
4. Select the "COM selection" menu
 - Select the "CAN" line and press Enter
5. Press the X key to return to the Bios menu
6. Select the "Start up mode" menu
 - Select the "Remote application" line and press Enter
7. Press the X key to return to the Bios menu
8. Select the "CAN" menu
 - Select the "Baudrate" line and check that it is 50K
 - Select the "Node ID" line and check that it is 126
9. Press the X key to return to the Bios menu
10. Select the "Application" menu and press Enter.

The display will once again retrieve data from the controller. This process will take about 5 minutes.

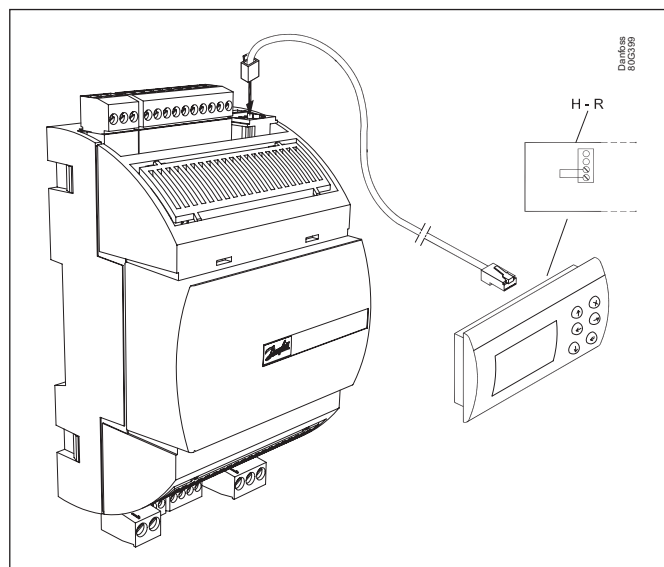

Connections

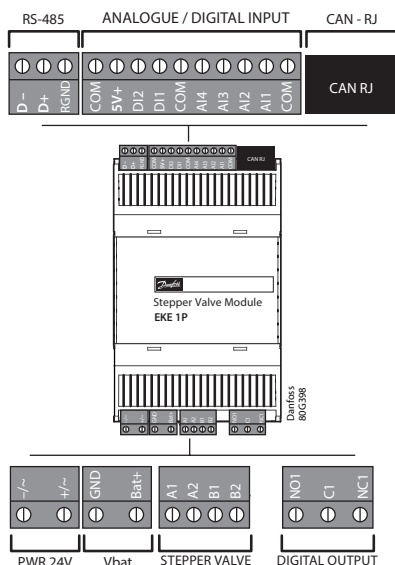

Valve connection

CCMT/ETS/CCM	ETS 6	EKE 1P
White	Orange	A1
Black	Yellow	A2
Red	Red	B1
Green	Black	B2

Application 1 driver configuration

AI4 open circuit or connected to 0 V (COM): high-pressure valve driver
AI4 connected to 5 V+: receiver valve driver

Recommended wire size and cable distance between EKE controller and stepper motor valve

Cable length	1 – 15 m
Wire diameter	0.52 / 0.33 mm ² (20 / 22 AWG)

Technical specifications

I/O	Type	No.	Specification
Analogue inputs	Voltage	2	Max. 15 V input voltage Do not connect voltage sources to unpowered units without limiting the current to analogue inputs (overall 80 mA). Open circuit HW diagnostics available for voltage input on: AI4 AI3* 0 – 5 V ratiometric AI4 0 – 5 V, 0 – 10 V
		2	AI1*, AI2*
	Auxiliary Supplies	1	5 V + Sensor supply: 5 V DC / 15 mA, overload protection approximately 150 mA
Digital inputs	Voltage free contacts	2	DI1*, DI2 Steady current minimum 1 mA Cleaning current 100 mA at 15 V DC On: RIL <= 300 Ω Off: RIH >= 3.5 k Ω
Digital output	Relay	1	C1-NO1* Normally Open: 3 A General purpose, 250 V AC, 100 k cycle Normally Open: 3 A Inductive (AC-15), 250 V AC, 100 k cycle Normally Closed: 2 A General purpose, 250 V AC, 100 k cycle
Stepper motor	Bipolar / unipolar	1	Stepper valves: A1, A2, B1, B2 Bipolar and unipolar stepper motor output: - Danfoss CCMT 3L - CCMT 8L / CCMT 0 – CCMT 42 / CCM 10 - CCM 40/ETS 6 - ETS 400/ CTR 20 Other valves: - speed 10 – 400 pps - drive mode 1/8 microstep - max. peak phase current: 1.2 A (848 mA RMS) - max. drive voltage 40 V - max. output power 12 W
Battery backup		1	VBATT: 18 – 24 V DC (24 V DC recommended) - Leakage: <15 μA @30 V DC - max. battery current: 850 mA at 18 V - battery alarm will be activated below 16 V DC Required power to do one closing of stepper valve: ETS 6 : 110 J / 30 V mAh ETS 12.5 - ETS 400 : 60 J / 17 V mAh KVS 15 / KVS 42 : 60 J / 17 V mAh ETS 12C - ETS 100C : 55 J / 15 V mAh KVS 2C / KVS 5C : 55 J / 15 V mAh CCMT 2 - CCMT 8 : 60 J / 17 V mAh CCMT 16 - CCMT 42 : 175 J / 49 V mAh CCMT 3L - CCMT 8L : 60 J / 17 V mAh CTR 20 : 60 J / 17 V mAh
Communication	RS-485 RTU	1	RS-485* Galvanic isolation No built-in termination
	CAN	1	CAN – RJ Application 1: Connect directly to AK-PC Application 2: Connect directly to graphical display, MMIGRS2. Activate the termination on the graphical display.

* Only used in application 1

Technical Data

General specification

Feature	Description
Power supply	Galvanic isolation by switch mode power supply Input voltage rating (AC): 24 V AC \pm 20 % (19.2 – 28.8 V AC) Input frequency (AC): 50 / 60 Hz Input voltage rating (DC): 24 V DC (20 – 40 V DC) Provides 5 W at 5 V and 15 V outputs isolated from the 24 V input Insulation between power supply and the extra-low voltage
Power Consumption	Total Power consumption with following valve in operation and MMIGRS2 connected to the controller: CCMT 16 - CCMT 42 : 15 V A / 10 W ETS 6 : 11 V A / 7.5 W ETS 12C - ETS 100C : 20 V A / 14 W KVS C : 20 V A / 14 W ETS 12.5 - ETS 400 : 7 V A / 5 W CCMT 2 - CCMT 8 : 7 V A / 5 W CCMT 3L - CCMT 8L : 9 V A / 6 W CTR 20 : 7 V A / 5 W
Plastic Housing	DIN rail mounting complying with EN 50022 Self-extinguishing V0 according to IEC 60695-11-10 and glowing / hot wire test at 960 °C according to IEC 60695-2-12 Material used for Enclosure are UL94-V0 and RoHS compliant Ball test: 125 °C according to IEC 60730-1 Leakage current: \geq 250 V according to IEC 60112
Connectors	Plug able Screw connector Pitch 3.5 mm, relay and power connector Pitch 5 mm, CAN MMI: Modular Jack 6P4C Material used for connectors are RoHS and UL approved
Operating conditions	-20 – 60 °C, 90% RH non-condensing
Storage / Transport conditions	-30 – 80 °C, 90% RH non-condensing
Vibration and shock	According to IEC 60068-2-27 Ea
Integration	In Class I and / or II appliances
Index of protection	IP40 only on the front cover
PCB protection	None (no conformal coating)
Period of electric stress across insulating parts	Long
Resistance to heat and fire	Category D
Immunity against voltage surges	Category II
Software class and structure	Class A
Approvals	CE compliance: This product is designed to comply with the following EU standards: <ul style="list-style-type: none"> • Low voltage guideline: 2014/35/EU • Electromagnetic compatibility EMC: 2014/30/EU and with the following norms: <ul style="list-style-type: none"> – EN61000-6-1. EN61000-6-3 (immunity and emission standard for residential. commercial and light-industrial environments) – EN61000-6-2. EN61000-6-4 (immunity and emission standard for industrial environments) – EN60730-1 and EN60730-2-9 (Automatic electrical controls for household and similar use) RoHS compliance to 2011/65/EU and no components from negative list acc. to 500B0751 UL approval

Electrical specification

Feature	Type	Description
Protection	Short circuit	Motor driver: dissipative over current protection
	Over voltage	Analogue input: current limit and internal clamp diode Digital input: current limit and internal clamp diode Communication: transreceiver IC
	Over temperature	Motor driver: thermal shutdown at 150 °C
	Unstable Digital input	Continuous variation of the digital input state

Installation considerations

Accidental damage, poor installation, or site conditions, can give rise to malfunctions of the control system, and ultimately lead to a plant breakdown.

Every possible safeguard is incorporated into our products to prevent this. However, a wrong installation, for example, could still present problems.

Electronic controls are no substitute for normal, good engineering practice.

Danfoss will not be responsible for any goods, or plant components, damaged as a result of the above defects. It is the installer's responsibility to check the installation thoroughly, and to fit the necessary safety devices.

Special reference is made to the necessity of signals to the controller when the compressor is stopped and to the need of liquid receivers before the compressors. Your local Danfoss agent will be pleased to assist with further advice, etc.

Mounting/dimensions

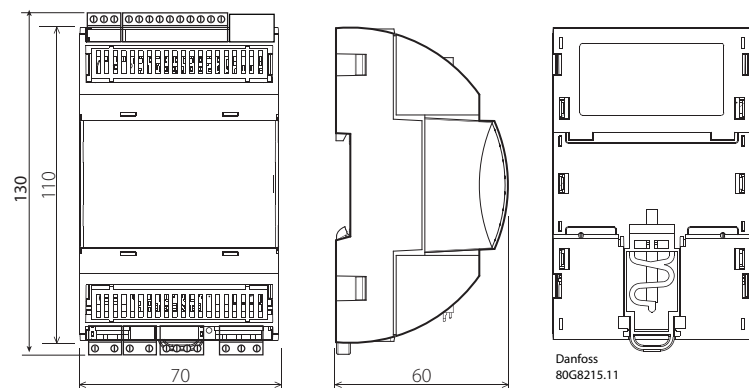

For DIN rail mounting only (IP20)

Ordering

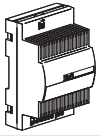
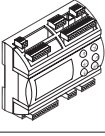
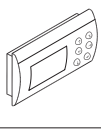
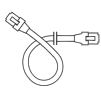
Type	Function	Operation	Supply voltage	Code no.	
EKE 1P	Stepper Valve Extension Module		Via AK-PC or MMIGRS2	24 V	080G0325
EKE 2U	Back-up power module			24 V	080G5555
AK-PC 572	Capacity controller		With buttons and display	24 V	080G0320
MMIGRS2	Display unit		With buttons and display		080G0294
	Wire for display unit		L = 1.5 m, 1 pcs		080G0075
			L = 3 m, 1 pcs		080G0076

ENGINEERING
TOMORROW

