

Installation guide

Filter drier, shell with cross gasket

Type DCR, DCR/H, DCR E



023R9543

023R9543

Refrigerants:

DCR Standard (A1, Group 2)

R1233zd, R134a, R407A, R407C, R407F, R407H, R410A, R422B, R422D, R448A, R449A, R449B, R450A, R452A, R513A, R515B, etc.

For other refrigerants, please contact Danfoss representative.

Media Temperature: -40 - 70 °C / -40 - 160 °F

DCR/H (A2L, Group 1) – UL listed, for American market use only

R1234yf, R1234ze, R32, R444B, R452B, R454A, R454B, R454C, R455A, R457A, R516A, etc.

*Also compatible with DCR Standard Refrigerants.

DCRE (A3, A2L, Group 1) – PED approved

R1234yf, R1234ze, R32, R444B, R452B, R454A, R454B, R454C, R455A, R457A, R516A, R290, R600a, etc.

*Also compatible with DCR Standard Refrigerants.

Design

DCR and DCR/H

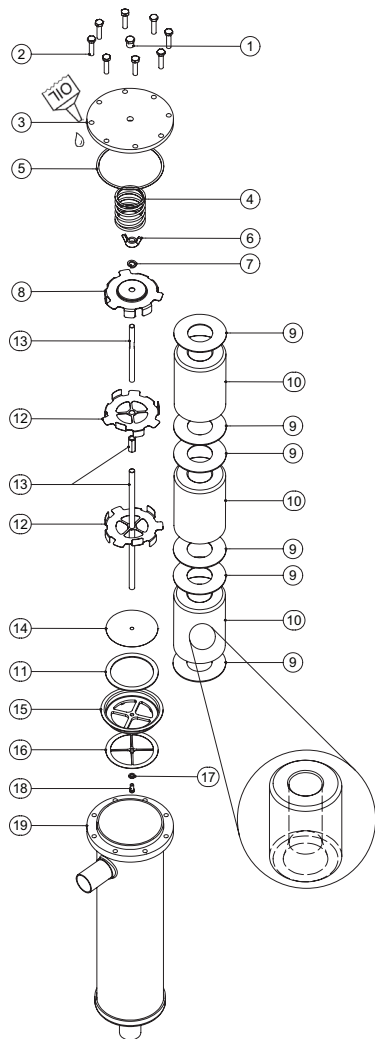

DCR E

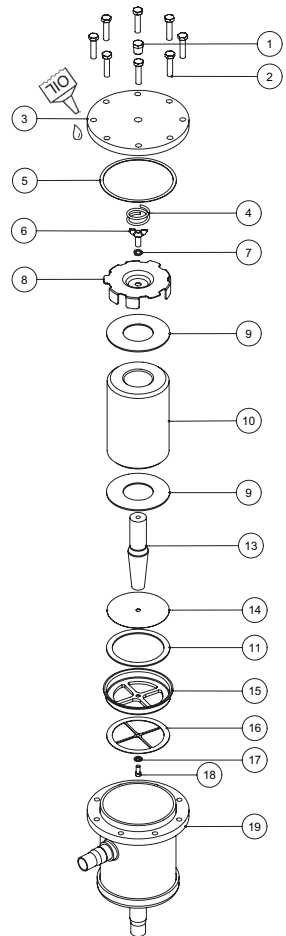

Pos.	Description
1	Plug for cover
2	Bolts for cover
3	Top cover
4	Spring
5	Top cover gasket
6	Wing nut (DCR) / Bolt (DCRE)
7	Lock washer
8	Top plate
9	Core felt gasket
10	Solid core
11	Core holder felt gasket
12	Core plate
13	Distance rod
14	Wire Mesh
15	Core holder
16	Cross gasket
17	Washer
18	Hex socket head screw
19	Shell

Inner taper of core always facing towards filter outlet. This apply for all DCR Families.

Імпортер: ТОВ з іі "Данфосс ТОВ" 04080, Київ 80, п/с 168, Україна

Info for UK customers only: Danfoss Ltd., 22 Wycombe End, HP9 1NB, GB

Installation

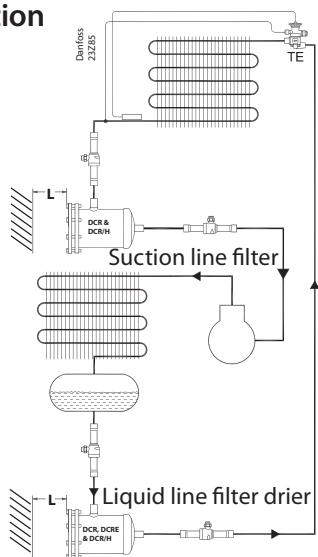

Type	L minimum		Maximum working pressure PS / MWP [bar] / [psig]	
	[mm]	[in]		
DCR DCR/H	048	170	7	46 / 667 *
DCR DCR/H	096	310	13	46 / 667 *
DCR DCR/H	144	310	13	35 / 507 ¹⁾ 46 / 667 ²⁾
DCR DCR/H	192	310	13	28 / 406 ¹⁾ 40 / 580 ²⁾
DCRE	048	170	7	50 / 725

¹⁾ For usage with strainer or as a receiver application

²⁾ For "drier" application using all the permissible cores

³⁾ * For either 1* or 2*

MWP shall not be less than the pressure outlined in sect 9.2 of ANSI/ASHRAE 15 for the refrigerant used in the system. After charging, the system shall be marked with the refrigerant and oil used.



"The DCRE can only be used for A2L when the solid core is placed. DCRE is not allowed to be used as receiver."

Brazing



Keep flames away from body

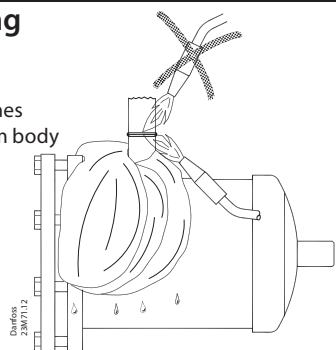

Welding

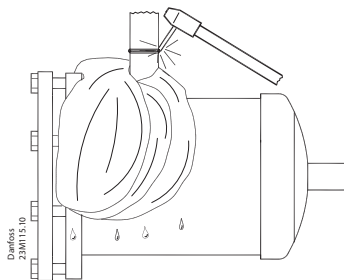

Customer best practice will still be needed:

- Use wet wrap when installing.
- Braze the joints.
- Let them cool down.
- Clean the brazing /welding area after the installation (remove remaining flux with a brush).
- This is an important operation and needs to be done with great care to remove all remaining flux.
- Paint / Anti-corrosive needs to cover all open steel parts, areas where the black original paint has been burnt due to brazing and at least 3 cm approx of the copper.
- Paint the joints twice.

Connector type	Brazing material
Copper	Min. 5 % Ag
Steel	Silver-flu 55 + Easy-flow flux



Do not install gasket before soldering.

Note: Confirm correct top cover Gasket is selected.

- There are 2 gaskets:
 - DCR and DCR/H
 - DCRE

Gasket

Pos 5

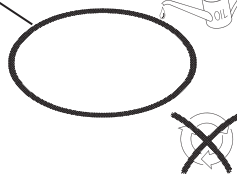

Note: Do not reuse the gasket

How to tighten the bolts

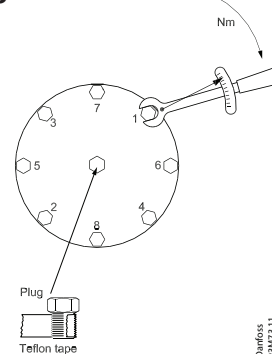

	DCR M8-1.5 x 35mm A2-70 Hex head	DCRE M10-1.5 x 40mm A2-70 Hex head	DCR/H M8-1.5 x 35mm G12.9 Socket head
Step 1	Fingertighten all bolts		
Step 2	3 Nm / 2.21 ft lb	5 Nm / 3.69 ft lb	4 Nm / 2.95 ft lb
Step 3	10 Nm / 7.37 ft lb	20 Nm / 14.75 ft lb	13 Nm / 9.59 ft lb
Step 4	20 Nm / 14.75 ft lb	35 Nm / 25.81 ft lb	25 Nm / 18.44 ft lb
Step 5	28 Nm / 20.65 ft lb	50 Nm / 36.88 ft lb	35 Nm / 25.81 ft lb

Optional Fuse and/or Plug, recommended tightening torques:

Fuse: 1/4" NPT - 3/8" Flare: 20 Nm / 14.75 ft-lb applying 2 to 3 wraps of teflon tape.

Plug: 1/4" NPT: 50 Nm / 36.87 ft-lb applying 2 to 3 wraps of teflon tape.

Reference

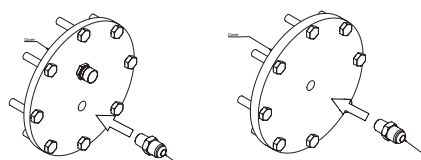

The torque values mentioned only apply to bolts supplied by Danfoss.