

User Guide

Case/room controller (EEV) Type **AK-CC55 Single Coil** and **AK-CC55 Single Coil UI**

SW Ver. 1.7x

For refrigeration appliances and cold storage rooms.



Contents

Introduction	6
Portfolio overview	7
Function overview	7
Connectivity	8
Data communication	8
AK-CC55 Single Coil and Single Coil UI	9
External display	9
Controller functionality	10
Functions	10
Injection control	10
Adaptive superheat control	10
Adaptive liquid control	11
Liquid injection by use of stepper valve	11
Oil recovery	11
Adaptive liquid control (option 1 and 2)	12
Fixed opening degree (option 3 and 4)	12
Safety	12
Temperature control	12
Food temperature sensor	13
Temperature monitoring	13
Thermostat bands	13
Night setback of thermostat value	13
Temperature sensor types	14
Appliance cleaning	15
Appliance shutdown	15
Defrost control	16
Electrical defrosting	16
Hot gas defrosting	16
Natural defrost	16
Start of defrost	17
Stop of defrost	17
Defrost sequence	17
Real-time clock	19
Coordinated defrost	19

Adaptive defrosting	19
4 different adaptive defrost modes	19
Melt function	20
Control of two compressors (only with custom set-up)	20
Rail heat	21
Fan	22
Light function	23
Night blind	24
Humidity control	24
Heating function (only with custom set-up)	26
Digital inputs	26
Forced closing	27
Door contact	27
Display	27
Override	28
Applications	29
AK-CC55 connections and application options	30
Application set-ups and IO connections	31
Product identification	34
AK-CC55 Single Coil connections	35
Data communication	35
AKV info	35
External solid state relay for rail heat	35
AKS 32R info	36
Coordinated defrost via cable connections	36
External display AK-UI55	36
Connections	37
Replacing AK-CC 550 with AK-CC55	38
Operation	40
Operation via data communication	40
Direct operation	40
Operation via AK-UI55 Set	40
Parameter groups when operating via display	42
Get a good start	42
AK-UI55 display menu (SW ver. 1.7x)	44
Thermostat	44

Alarm settings	44
Compressor	45
Defrost	45
Injection control	46
Fan control	46
Defrost schedule	46
Humidity control	47
Miscellaneous	47
Control	49
DO config and manual	50
Service	51
Operation via AK-UI55 Bluetooth	53
AK-CC55 connect menu (SW ver. 1.7x)	54
Start / Stop	54
Configuration	54
Thermostat control	56
Alarm limits and delays	57
Humidity control	59
Injection control	59
Defrost control	60
Defrost schedules	62
Compressor	63
Fan control	63
Railheat control	64
Light/Blinds/Cleaning control	64
Display control	65
Alarm relay priorities	66
Miscellaneous	66
Advanced	67
Fault message	69
Operating status	71
Product specification	72
Technical data	72
Electrical specifications	72
Sensor and measuring data	72
Input and output relay specifications	72

Function data	73
Environmental conditions	73
Dimensions	73
Ordering	74
Certificates, declarations, and approvals	75
Statements for the AK-UI55 Bluetooth display	75
Online support	77

Introduction

Application

Complete refrigeration appliance control with great flexibility to adapt to refrigeration appliances and cold storage rooms.

Advantages:

- Universal controller for several different refrigeration appliances
- Quick set-up with predefined settings
- Easy configuration and service using a mobile app with Bluetooth
- Energy optimization of the whole refrigeration appliance
- Adaptive Minimum Stable Superheat (MSS) control is performed with lowest possible superheat
- Allows the suction pressure to be raised several degrees
- Adaptive Liquid Control (ALC) can be performed with superheat down to 0 degrees on transcritical CO₂ systems with liquid ejectors

Principle

The temperature in the appliance is registered by one or two temperature sensors which are located in the air flow before the evaporator (S3) or after the evaporator (S4) respectively. A setting for thermostat, alarm thermostat and display reading determines the influence the two sensor values should have for each individual function.

In addition, product sensor S6, which can be optionally placed in the appliance, can be used for registration and alarming of the temperature near the food items.

The temperature of the evaporator is registered with the S5 sensor which can be used as a defrosting sensor.

In addition to the output of the electronic AKV injection valve, the controller has relay outputs which are defined by the application setting.



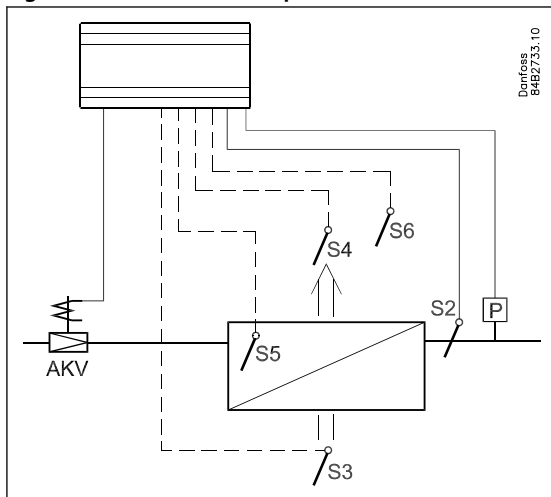

Figure 1: AK-CC55 with evaporator, AKV valve and sensor positions



Portfolio overview

The AK-CC55 portfolio contains four controllers with different functionalities and application settings, as outlined in the table.

Table 1: AK-CC55 Portfolio

	AK-CC55 Compact	AK-CC55 Single Coil	AK-CC55 Single Coil UI	AK-CC55 Multi Coil
Product image				
Valve	1 x TXV or AKV	1 x AKV	1 x AKV	3 x AKV
Digital Output	3	5	5	4
Digital input	1 (2)	3 (2)	3 (2)	3 (2)
Analogue Output	1	1	1	1
Analogue Input	5 (4)	6 (7)	6 (7)	6 (7)
Display	1 remote	2 remote	1 remote + 1 Integrated	2 remote
Comm. module	Modbus	Modbus	Modbus	Modbus
Optional comm. module		LON module	LON module	LON module

Function overview
Table 2: AK-CC55 function overview by type

Application	AK-CC55 Compact	AK-CC55 Single Coil AK-CC55 Single Coil UI	AK-CC55 Multi Coil
AKV - application (electrically operated expansion valve)	x	x	x
0 – 10 V to control external stepper driver		x	
TXV - application (thermostatic expansion valve + solenoid valve or compressor)	x		
Remote hot gas - application		x	
One valve, one evaporator, one refrigeration section	x	x	x
One valve, one evaporator, two refrigeration sections		x	
One valve and two evaporators, two refrigeration sections		x	
Two valves and two evaporators (same refrigeration section)			x
Three valves and three evaporators (same refrigeration section)			x
Custom configuration of relay outputs	x	x	
Two compressors	x	x	
Heating function	x	x	
Control of air humidity		x	x
Adaptive superheat	x	x	x
Adaptive liquid control (zero superheat control for transcritical CO ₂ systems with liquid ejectors)	x	x	x
Adaptive defrosting		x	
Product sensor		x	
Oil recovery		x	
RS485 Lon, option (AK-OB55)		x	x

Connectivity

The diagram outlines the connectivity options presented by AK-CC55 for the design of system functionality.

Figure 2: Connectivity

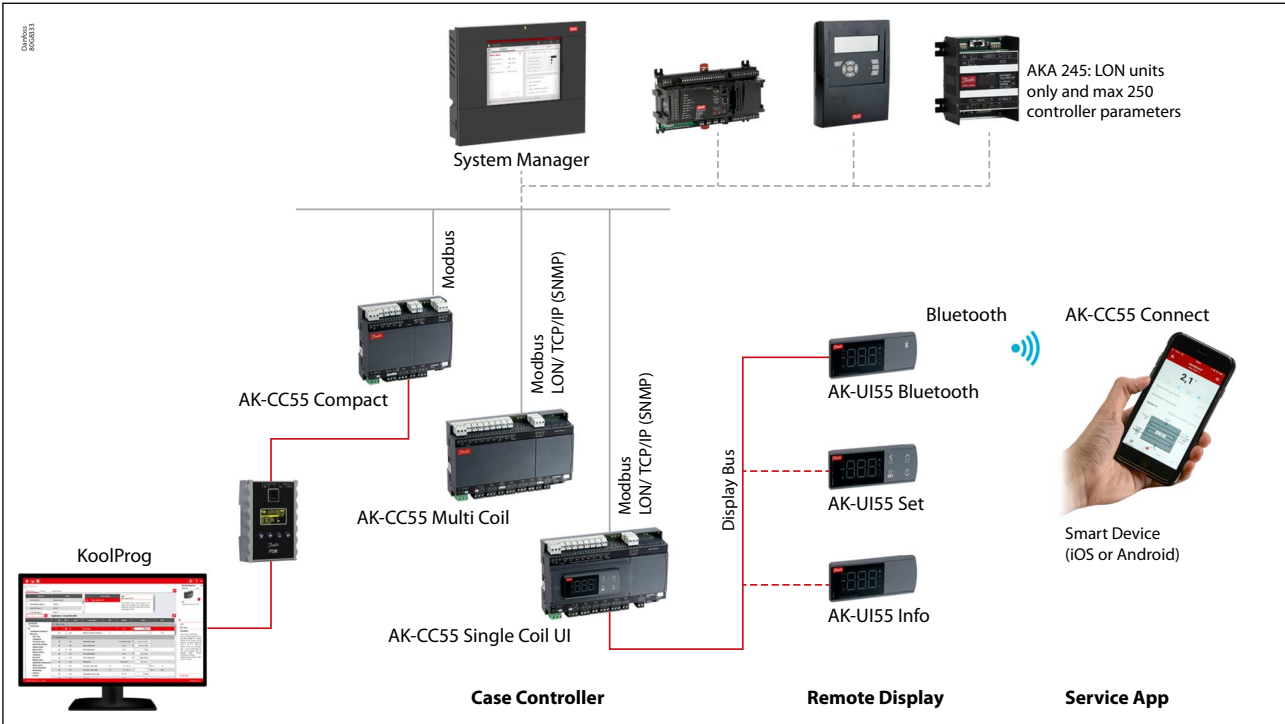

Data communication

The controller has built-in MODBUS data communication. If there is a requirement for a different form of data communication, a Lon RS 485 module can be inserted in the controller.

The connection must then be to the module.

Figure 3: Mounting of communication module

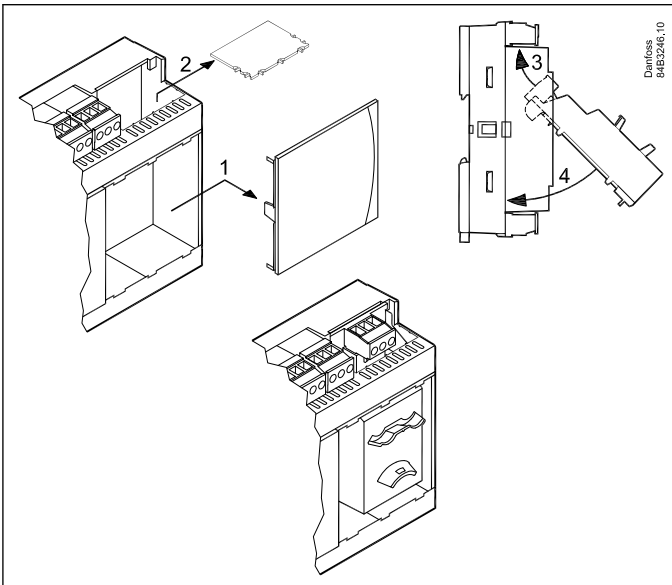

AK-CC55 Single Coil and Single Coil UI

AK-CC55 Single Coil – Controlling one EEV valve.

An application mode setting will configure inputs and outputs for the desired use. There are nine applications to choose from. Regulation is performed using an AKV expansion valve or an external stepper driver via Analogue Output A01.

Standard enclosure. Typically used for display cases where the controller is mounted in a tray.

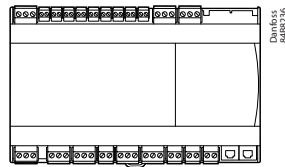

The standard enclosure can be expanded with one or two external displays.

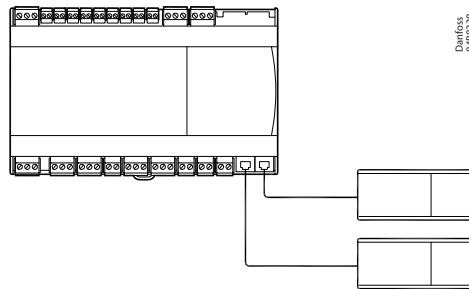

AK-CC55 Single Coil UI

Single Coil controller with built-in display. Same functionalities as AK-CC55 Single Coil.

Enclosure with built-in setting display. Typically used for cold rooms.

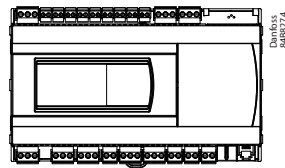

For controllers with built-in, only one external display can be connected.

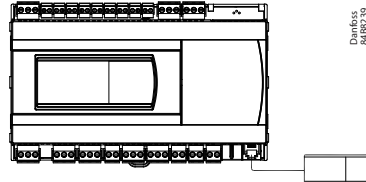

External display

There are three versions available with different functions:

- AK-UI55 Info: Temperature display.
- AK-UI55 Set: Temperature display with control buttons on the front.
- AK-UI55 Bluetooth: Temperature display with Bluetooth communication, for use with AK-CC55 Connect Mobile app.

Figure 4: AK-UI55 Info



Figure 5: AK-UI55 Set



Figure 6: AK-UI55 Bluetooth



Controller functionality

Functions

- Day/night thermostat with ON/OFF or modulating principle
- Product sensor S6 with separate alarm limits
- Switch between thermostat settings via digital input
- Adaptive control of superheat
- Adaptive liquid control
- Oil recovery (flushing oil back to condensing unit)
- Adaptive defrosting based on diagnostics
- Start of defrost via schedule, digital input, network or setting display
- Natural, electric or hot gas defrost
- Stop of defrost on time and/or temperature
- Coordination of defrosting among several controllers in a line-up
- Pulsing or ECO control of fans when thermostat is satisfied
- Appliance cleaning function for documentation of HACCP procedure
- Rail heat control via day/night load or dewpoint
- Humidity control in cold storage rooms
- Door function
- Control of two compressors
- Control of night blinds
- Light control
- Heat thermostat
- High accuracy inputs will guarantee a better measuring accuracy than stated in the standard EN ISO 23953-2 without subsequent calibration (Pt 1000 ohm sensor)
- Support of user-defined temp. sensor type
- Integrated MODBUS communication with the option of mounting a LonWorks communication card

Injection control

Adaptive superheat control

Liquid injection in the evaporator is controlled by an electronic injection valve of the type AKV. The valve operates as both expansion valve and solenoid valve. The controller opens and closes the valve based on sensor readings.

Figure 7: Adaptive superheat control with AKV valve

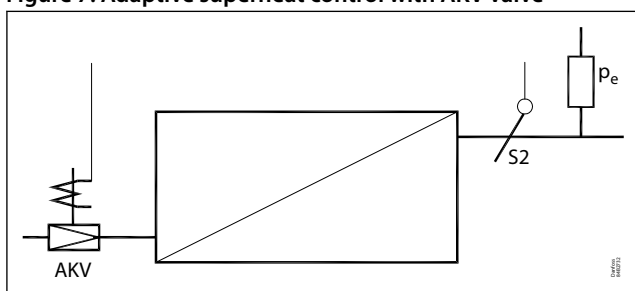

The superheat is measured via a pressure sensor P_e and temperature sensor S_2 . By using a pressure sensor, and temperature sensor a correct measurement of superheat is achieved under all conditions which ensures a very robust and precise control. The signal from one pressure transmitter can be shared by max. 10 controllers, but only if there is no significant pressure difference between the evaporators in question.

The function contains an adaptive algorithm which independently adjusts the valve's opening so that the evaporator constantly supplies optimum amount of refrigerant.

Adaptive liquid control

Adaptive liquid control is used in trans-critical CO₂ ejector systems, which allow liquid flow. When adaptive liquid control is initiated, the superheat of the evaporator will be minimized so that a controlled amount of liquid is present at the outlet of the evaporator.

This type of control requires that the controller receives an on/off signal from (for example) a suction accumulator in the suction line.

Figure 8: Adaptive liquid control with AKV valve

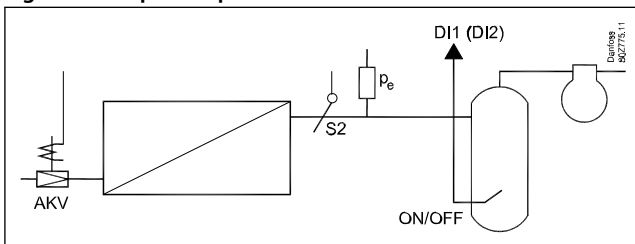

A level switch in the tank will register when the liquid level exceeds the max. level. When this happens, the controller will switch to dry expansion, and then back to liquid control when the liquid level has dropped. The function is defined in setting o02, o37 or o84.

The function can also be activated via data communication from a system unit. If the adaptive liquid control signal is lost, the controller will automatically switch back to dry expansion.

⚠ WARNING:

Accidental actuation may allow liquid throughput to the compressor. It is the installer's responsibility to ensure that signal loss to the controller will not result in liquid throughput to the compressor. Danfoss accepts no responsibility for damage resulting from inadequate installation.

Liquid injection by use of stepper valve

Instead of AKV, an external stepper driver can be connected to AO1 (0 – 10 V) to drive a stepper valve. DO1 (AKV output) is then configured to close a liquid line solenoid valve (LLSV) when the stepper valve output is 0%. The LLSV is also closed at power failure.

Figure 9: Injection control via step motor valve and liquid line solenoid valve (LLSV)

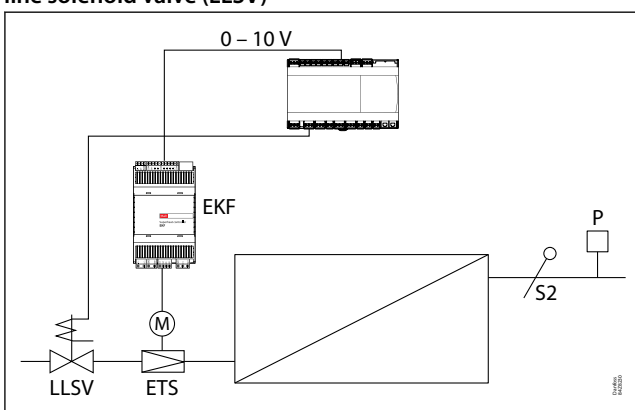

Oil recovery

In some multi evaporator systems, oil might accumulate in the evaporators over time. The oil recovery feature will help to get the oil back to the compressors/suction accumulator.

Oil recovery can be initiated via a digital input signal or as a network signal. When oil recovery is initiated, the valve opening degree will be increased to flush the oil out of the evaporator.

Oil recovery has the following control options:

- 0 = No oil recovery
- 1 = Adaptive liquid control + Normal fan control
- 2 = Adaptive liquid control + Fan OFF
- 3 = Fixed opening degree of valve + Normal fan control
- 4 = Fixed opening degree of valve + Fan OFF

Adaptive liquid control (option 1 and 2)

When oil recovery is initiated, the injection function will switch to adaptive liquid control, decreasing the superheat reference, increasing the valve opening degree and thereby achieving a controlled amount of liquid refrigerant at the outlet of the evaporator. As the compressor controller at the same time runs with a higher capacity/speed, this combination will result in a higher amount of returned oil.

Figure 10: Adaptive liquid control increases valve opening degree during oil return

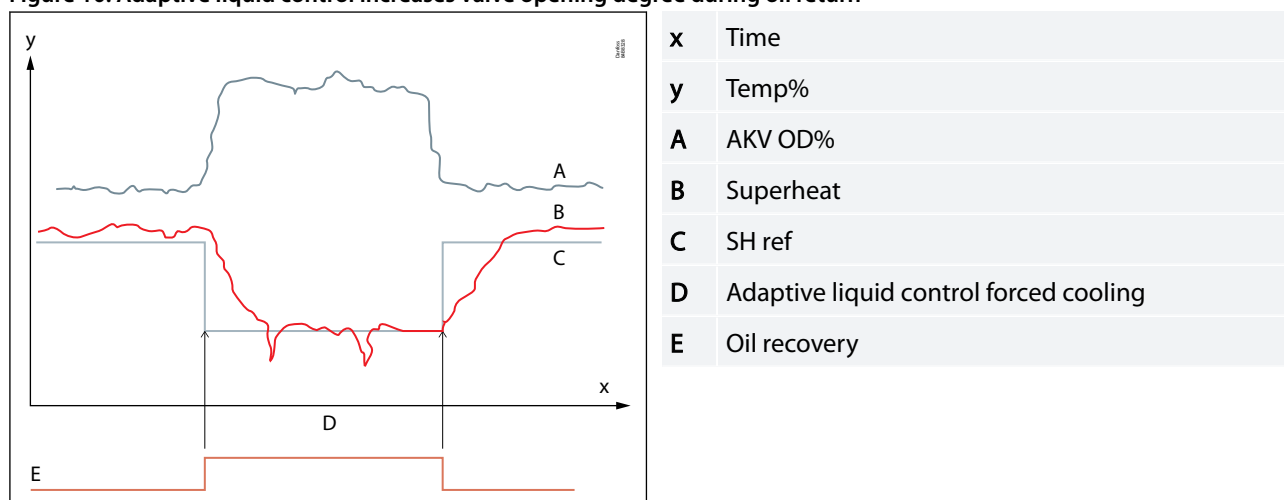

Fixed opening degree (option 3 and 4)

When oil recovery is initiated, the injection function will switch to a user-defined opening degree to flood the evaporator with refrigerant and thereby flush the oil back to the compressor/suction accumulator. However, this option provides no control or monitoring of the superheat and it is solely up to the user to ensure that the system design provides a safeguard of the compressors.

Safety

A couple of safety functions are in place to protect the preserved food from too low temperatures during an oil recovery cycle.

If an oil recovery has been ongoing for a longer period than the set "Max. oil recovery time", oil recovery will be stopped, and normal control resumed.

Oil recovery is stopped if the alarm air temperature decreases below the set low alarm limit.

Temperature control

The temperature in the appliance is registered by one or two temperature sensors which are located in the return air before the evaporator (S3) or after the evaporator (S4) respectively. A setting for the thermostat, night thermostat, alarm thermostat and display reading determines how much the two sensor values should influence each individual function, e.g. 50% of S4 will produce an equal value from both sensors.

The actual temperature control can take place in two ways:

1. As an ordinary ON/OFF regulation with a differential, or
2. As a modulating control where the temperature variation will not be nearly as high as in ON/OFF control

There is, however, a limit to the use of a modulating control as it can only be used in remote cabinets. It is not recommended to use modulating thermostat control in low temperature applications. In applications with one evaporator and one compressor the thermostat function with ON/OFF control should be selected. In remote cabinets, the thermostat function may either be selected for ON/OFF control or modulating control.

Table 3: Control methods

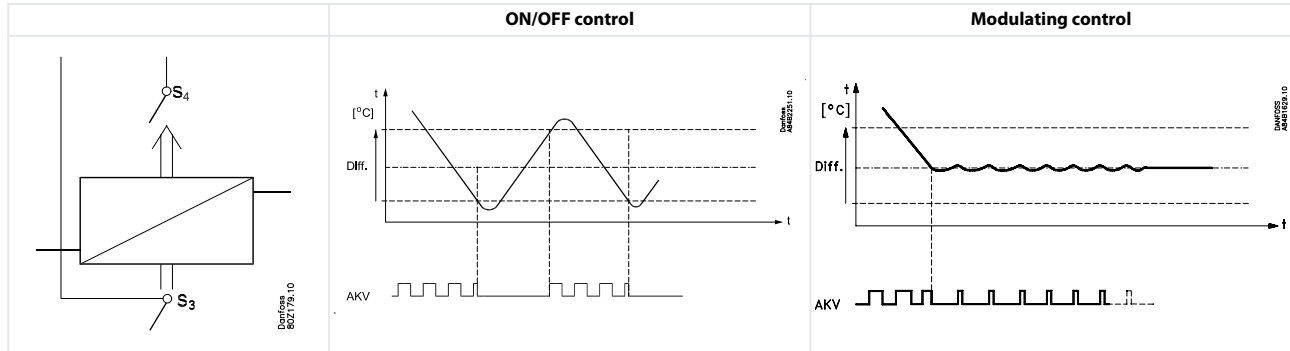

Food temperature sensor

A separate optional product sensor S6, which may be placed in the appliance, can also be used and can register and monitor the food temperature in the appliance. There are separate alarm limits and time delays for the product sensor.

Temperature monitoring

Just as is possible for the thermostat, the alarm monitoring can be set with a weighting between S3 and S4 so that you can decide how much the two sensor values should influence the alarm monitoring. Minimum and maximum limits can be set for alarm temperature and time delays. A longer time delay can be set for high temperature alarm. This time delay is active for pull-down after defrosting, appliance cleaning and start-up.

Thermostat bands

Thermostat bands can be used beneficially for appliances where different product types are stored, which requires different temperature conditions. It is possible to change between the two different thermostat bands via a contact signal on a digital input. Separate thermostat and alarm limits can be set for each thermostat band – also for the product sensor.

For the defrost control, separate defrost stop temperature and max. defrost time can be set for each thermostat band. For the compressor control it is possible to disable the second compressor in thermostat band 2 if required.

Figure 11: Thermostat band function with two different band settings

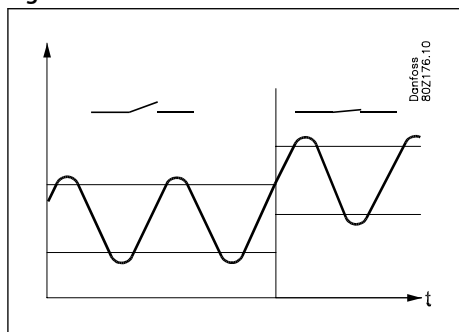

Night setback of thermostat value

In refrigeration appliances there may be big load differences between the shop's opening and closing hours, especially if night lids/blinds are used. The thermostat reference may be raised here without it having any effect on the product temperature.

Change-over between day and night operation can take place as follows:

- via an external switch connected to a digital input
- via a signal from the data communication system

Figure 12: Thermostat band function with Night setback

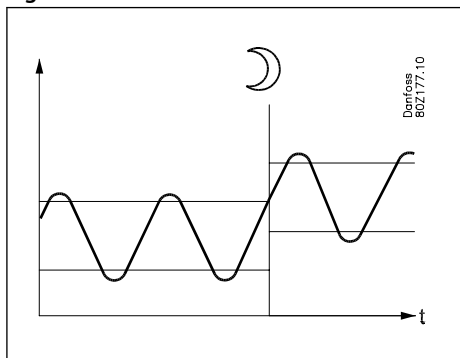

Temperature sensor types

The S2 and S6 sensors always have to be Pt1000 sensors due to the high measuring accuracy.

For the S3, S4 and S5 sensors, the user can select between the following sensor types:

- 0=Pt1000 (Danfoss AKS 11)
- 1=PTC1000 (Danfoss EKS 111)
- 2=NTC 5k (Danfoss EKS 211)
- 3=NTC 10k (Danfoss EKS 221)
- 4 = User-defined

If "User-defined" is selected, three sensor measuring points must be provided and based on these three sensor points, a sensor characteristic is generated.

A sensor point is defined by setting a temperature value and the corresponding resistance value at this temperature. The resistance value is set via two values for kohm and ohm respectively. These values can be found in the data sheet for the sensor.

The three sensor points must be:

1. Lowest temperature in wanted measuring range
2. Highest temperature value in wanted temperature range
3. Temp. value in the middle where a high measuring accuracy is required

A sensor error is detected at temperature values below/above the min./max. temperature values typed in for the sensor points.

Figure 13: Example of sensor points from a NTC sensor

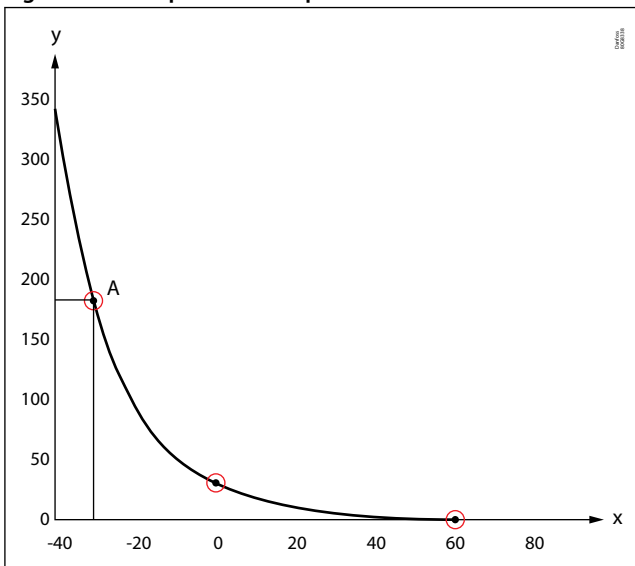

x	Temp [°C]
y	R [kohm]
A	Sensor point (-30 °C, 180 kΩ)

Limitations:

A user defined temperature sensor can only be defined within the temperature range from -40 – +60 °C and within the resistance range from 400 – 179.999 ohm.

When applying a new user defined sensor type, please contact Danfoss for validation of compliance and measuring accuracy.

Appliance cleaning

This function makes it easy for the shop’s staff to carry out a cleaning of the appliance according to a standard procedure. Appliance cleaning is activated via a pulse signal – as a rule via a key switch placed on the appliance or via the AK-CC55 Connect mobile app.

Appliance cleaning is carried out via three phases:

1. At the first activation, the refrigeration is stopped, but the fans keep on operating in order to defrost the evaporators. "Fan" is shown on the display.
2. At the second activation, the fans are also stopped and the appliance can now be cleaned. "OFF" is shown on the display.
3. At the third activation, refrigeration is recommenced. The display will show the actual appliance temperature, o97 setting.

When appliance cleaning is activated, a cleaning alarm is transmitted to the normal alarm recipient. A later processing of these alarms will document that the appliance has been cleaned as often as planned.

There are no temperature alarms during appliance cleaning.

Table 4: Appliance cleaning function

-	+	+	°C
1	÷	+	Fan
2	÷	÷	Off
3	+	+	°C

Appliance shutdown

The function closes the AKV valve and all outputs are switched off. The cooling appliance is stopped like the "Main switch", but this happens without an "A45 standby alarm". The function can be enabled by a switch on the DI input or via a setting through data communication.

Defrost control

Defrost method

The following defrost methods can be selected:

- 0: None
- 1: Electrical
- 2: Hot gas defrost (Simple)
- 3: Natural

Electrical defrosting

At electrical defrost, an electrical heater is placed in front of the evaporator and the fan will “pull” the hot air through the evaporator during defrosting.

Figure 14: Electrical defrosting

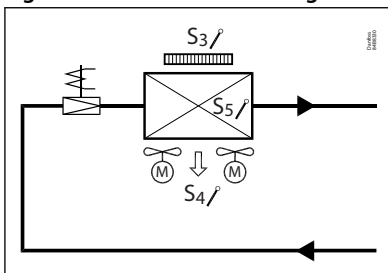

Hot gas defrosting

Remote hot gas defrost is supported in application mode 5. The hot gas defrost sequence covers control of the hot gas valve, suction valve and drain valve. It is intended for smaller systems in e.g. supermarkets – the functional content has not been adapted to industrial systems with large refrigerant charges.

Figure 15: Hot gas defrosting

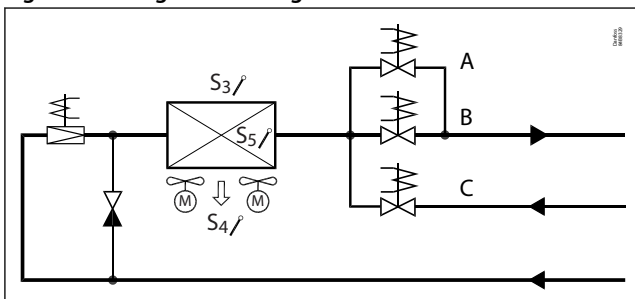

- | | |
|---|---------------|
| A | Bypass valve |
| B | Suction valve |
| C | Hot gas valve |

Simple hot gas defrosting

If hot gas defrost is selected in application 1-3, the compressor will be running during defrost and a hot gas valve (HG) is bypassing the compressor discharge gas to the evaporator inlet and thereby the evaporator is defrosted.

Natural defrost

At natural defrost, the ice is melted by running the fans and thereby circulating warm air through the evaporator.

Figure 16: Natural defrost

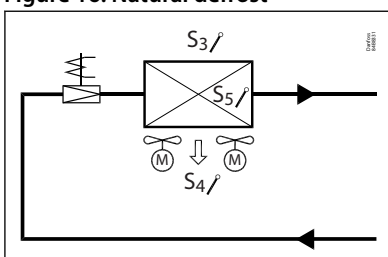

Start of defrost

A defrost can be started in different ways:

Interval:

Defrost is started at fixed time intervals like e.g. every eighth hour. An interval must ALWAYS be set to a "higher" value than the period set between two defrostings when a schedule or network signal is used.

Week schedule:

Here defrost can be started at fixed times of the day and night. However, max. 6 defrosts per day.

Contact:

Defrost is started with a contact signal on a digital input.

Figure 17: Defrost start

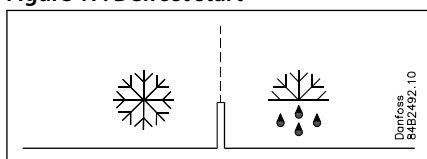

Network:

The defrost start signal is received from a system manager via data communication.

Adaptive defrost:

Here defrosting is started based on intelligent registering of evaporator performance.

Max. thermostat runtime:

When the aggregate time has passed a preset value, a defrost will be initiated.

Manual:

An extra defrost can be activated from the defrost button on the AK-UI55 Set display (though, not with application 5) or via a parameter setting. All the mentioned methods can be used in parallel – if just one of them is activated, a defrost will be started.

Stop of defrost

Defrosting can be stopped by either:

- Time
- S4A temperature (with time as safety)
- S5A temperature (with time as safety)
- S5A and S5B temperatures (with time as safety)

When the selected defrost stop sensor reaches the set defrost stop limit, the defrost is terminated. If the defrost stop sensor does not reach the set defrost stop limit within the set max. defrost time, the defrost will be terminated on time.

Minimum defrost time

When using hot gas for defrosting, the heat is coming from within the evaporator, and this means that the S5 sensor is rising fast when the inner layer of ice is melted. This will sometimes cause parts of the evaporator not to be defrosted when defrost is terminated on S5 evaporator temperature.

To prevent this, the user is given the option of setting a minimum defrost time. When a defrost is initiated, it will have to run for the set minimum time even if the set defrost stop limit has been reached by the selected defrost stop sensor.

Defrost sequence

When a defrost is initiated, the controller will run through the following sequence:

1. **Pump down:** where the evaporator is emptied of refrigerant
2. **Hot gas inj. delay (Hot gas only):** where suction valve is given time for closing
3. **Defrost:** where the ice on the evaporator is melted
4. **Hold after defrosting:** where multiple controllers wait for each other (coordinated defrost)
5. **Drip off:** where remaining water is dripping off evaporator
6. **Drain delay (Hot gas only):** where the drain valve is opened to drain the liquid refrigerant
7. **Fan delay:** where the fans are restarted when the remaining water on the evaporator has turned into ice

Figure 18: Electrical defrost sequence

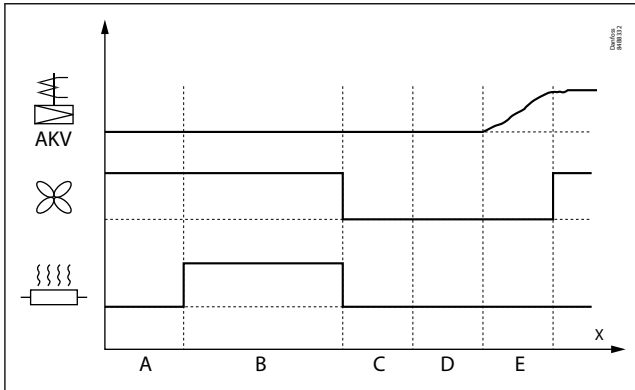

x	Time
A	Pump down
B	Defrost
C	Hold
D	Drip
E	Fan delay

During an electrical defrost sequence where the defrost heater is ON during defrost, AKV valve is closed and fans are running during defrost but stopped during drip.

Figure 19: Remote hot gas defrost sequence

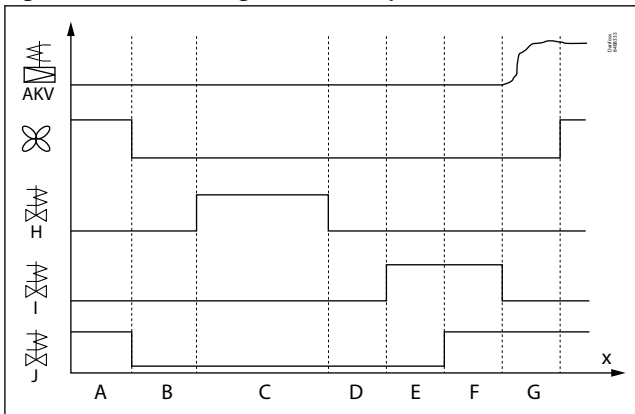

x	Time
A	Pump down
B	Hot gas injection delay
C	Defrost
D	Hold
E	Drain
F	Drip
G	Fan delay
H	Hot gas valve
I	Drain
J	Suction

Remote hot gas defrost sequence where suction valve and drain valves are closed while hot gas valve is injecting hot gas into the evaporator. After defrost, the drain valve is opening to drain the evaporator for liquid refrigerant and then the suction valve is opening. When the water has dripped off the evaporator, liquid injection is started via the AKV valve and the fans start when the evaporator temperature has reached the fans' start temperature.

Fan control during defrost

During the defrost sequence, the evaporator fans can be controlled in one of the following ways:

1. The fan is OFF in the entire defrost sequence
2. The fan is ON during the entire defrost sequence except during fan delay state
3. The fan is ON during defrost state and is OFF in the rest of the defrost sequence
4. Like option 2, however the fans can be stopped if the selected defrost stop sensor exceeds a set fan stop limit

Real-time clock

The controller has a built-in real-time clock which can be used to start defrosts. This clock has a power reserve of four days.

If the controller is equipped with data communication, the clock will automatically be updated from a Danfoss system manager.

Coordinated defrost

There are two ways in which coordinated defrost can be arranged.

Figure 20: Coordinated defrost options

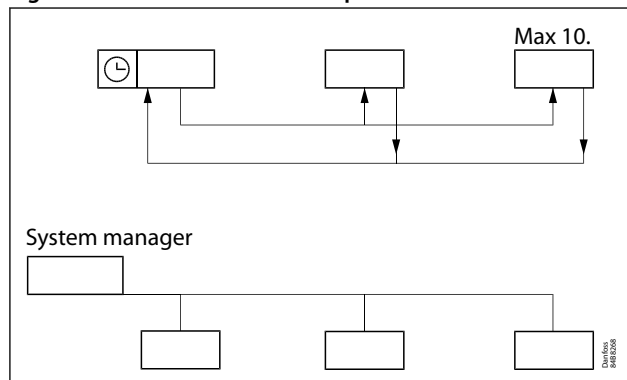

Either with wire connections between the controllers or via data communication:

Wire connections

The digital input DI2 must be configured for coordinated defrost and wiring must be connected between the relevant controllers. When one controller starts a defrost, all the other controllers will follow suit and likewise start a defrost. After the defrost, the individual controllers will move into waiting position. When all are in waiting position there will be a change-over to refrigeration.

Coordination via data communication

Here the system manager handles the coordination.

The controllers are gathered in defrosting groups and the system manager ensures that defrosting is started in the group according to a weekly schedule.

When a controller has completed defrosting, it sends a message to the system manager and then goes into a waiting position. When every controller in the group is in a waiting position, refrigeration is again permitted in all the individual controllers.

Adaptive defrosting

The Danfoss adaptive defrost algorithm detects the amount of ice build-up and cancels a scheduled defrost if it is not needed, or it can be set up to only perform defrost if the evaporator air flow is getting interrupted by frost or ice.

The overall concept is based on comparison of the energy uptake on the refrigerant flow side with the energy emission on the air flow side. When the evaporator is clean, an energy balance is assumed, while a growing imbalance can be identified when ice formation is build up on the evaporator surface ending up with blocked airflow.

4 different adaptive defrost modes

0 Off

1. Monitoring

Can be set up in parallel to other defrost methods and generate an alarm in case of blocked air flow / ice-up of the evaporator. If flash gas issues are detected on the refrigerant flow side, a flash gas alarm is generated.

2. Adaptive skip day:

Allows the controller to cancel (skip) defrosts scheduled within day time. Defrosts scheduled at night operation will be carried through and not skipped. Only defrosts that are set up via a schedule in the frontend using master control functions or set up via the internal defrost schedule in the controller can be skipped.

3. Adaptive skip day and night:

With this set-up, the controller can allow to cancel (skip) defrosts scheduled both within day time and within night time. For both adaptive skip day and night max. 3 consecutive defrosts can be skipped, whereafter the 4th scheduled defrost will be performed even if only little ice should be present.

4. Full adaptive:

Full Adaptive mode is ideal for applications where defrost is not requested to be performed at a certain time, but can be performed whenever ice is starting to interrupt the airflow. It makes sense to combine this mode with the defrost interval timer as a safety timer.

Adaptive defrosting requires the following connections:

- Expansion valve type AKV
- Pe evaporator pressure and S2 gas out temperature
- Temperature signal from both S3 and S4. Sensors must be placed in the airflow/channel immediately before / after the evaporator.
- Condensing temperature Tc is distributed via the network from the system manager. If Tc is not received by the case controller, the adaptive defrost function is using default back-up values.

NOTE:

Adaptive parameters will be reset after a defrost has been initiated or at main switch in stopped or service mode. At start up with a warm evaporator (measured with S2 sensor), the evaporator is presumed clean. If the evaporator temperature is measured below 0.1 °C, adaptive defrost will request a defrost start to secure a clean evaporator.

Min. time between defrosts

There is a preset 2 hours minimum time between defrosts. This avoids that planned defrosts in accordance with the weekly schedule are carried out immediately after an adaptive defrost has been carried out. The time applies from when an adaptive defrost has been completed to when a planned defrost is again permitted. The adaptive defrost will not start defrosting with a shorter interval than the 2 hours either.

Melt function

This function will prevent the air flow in the evaporator from being reduced by frost created by uninterrupted operation for a long time.

The function is activated if the thermostat temperature has remained in the range between -5 °C and +10 °C for a longer period than the set melting interval. The refrigeration will then be stopped during the set melting period. The frost will be melted so that the air flow and hence the evaporator's capacity will be greatly improved.

Control of two compressors (only with custom set-up)

Two compressor steps can be controlled cyclic or sequentially. At cyclic control, two compressors must be of the same size, while in sequential control compressor step 1 can be larger than step 2.

Figure 21: Control of two compressors

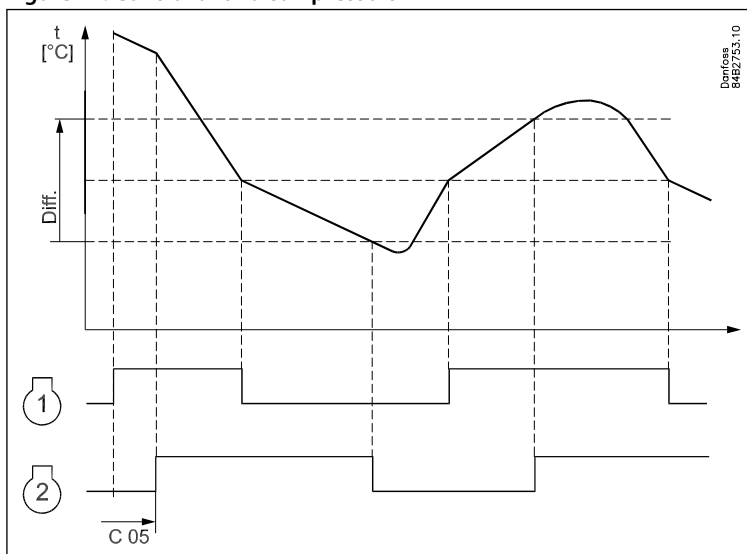

Cyclic control

When the controller demands refrigeration, it will first cut in the compressor with the shortest operating time. After the time delay, the second compressor will be cut in.

When the temperature has dropped to "the middle of the differential", the compressor with the longest operation time will be cut out.

The running compressor will continue until the temperature has reached the cut-out value. Then it will cut out. When the temperature again reaches the middle of the differential, a compressor will again be started.

If one compressor cannot maintain the temperature within the differential, the second compressor will also be started.

If one of the compressors has run on its own for two hours, the compressors will be changed over so that operational time is balanced.

The two compressors must be of a type that can start up against a high pressure.

The compressor's settings for "Min. On time" and "Min. Off time" will always have top priority during normal regulation. But if one of the override functions is activated, like e.g. defrost, door open function, case shutdown, forced closing, the "Min. On time" will be disregarded.

Sequential control

Compressor steps are controlled in the same manner as described for cyclic control, but compressor step 1 will always be started first and cut out as the last one. No time equalization is available in sequential control mode.

Rail heat

It is possible to pulse-control the power to the rail heat in order to save energy. Pulse control can either be controlled according to day/night load or dew point.

Relay or analogue output

A relay output can be used when long cycle times are permitted. If fast pulsing is required, the AO1/PWM output can be used. The output must be connected to an external power solid state relay. The cycle time must be configured for the relay output in o43 or for analogue output in P82.

Pulse control according to day and night

Various ON periods can be set for day and night operation. A cycle time is set as well as the percentage part of the period in which the rail heat is ON.

Figure 22: Rail heat control, day/night load

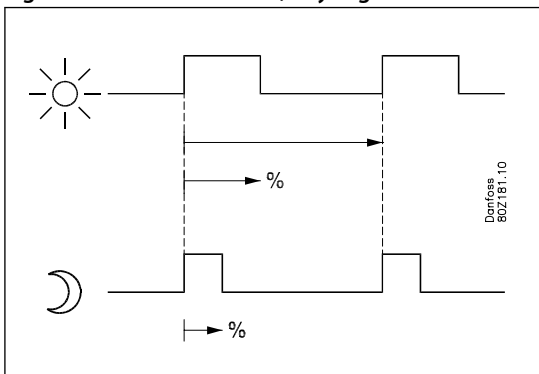

Pulse control according to dewpoint

In order to use this function, a system manager of the type AK-SM is required which can measure ambient temperature and humidity to calculate dew point and distribute to the appliance controllers. For this the rail heat's ON period is controlled according to the distributed dewpoint.

Two dew point values are set in the appliance control:

- One where the effect must be max. i.e. 100%. (o87)
- One where the effect must be min. (o86)

At a dewpoint which is equal to or lower than the value in 086, the effect will be the value indicated in o88. In the area between the two dew point values, the controller will manage the power to be supplied to the rail heat.

Figure 23: Rail heat control, dew point

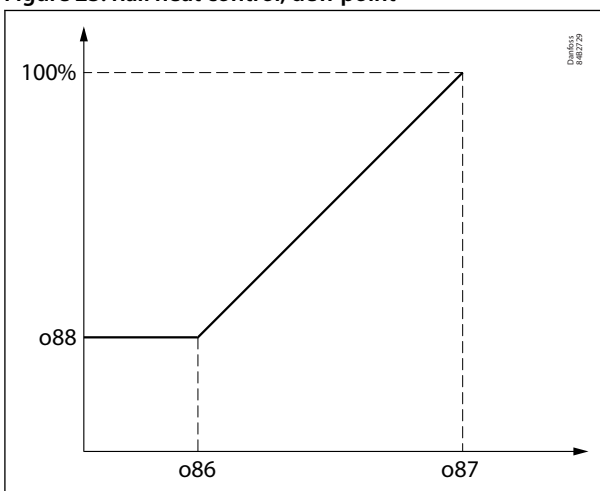

During defrosting

During defrosting rail heat will be active, as selected in setting d27.

Fan

Pulse control

To obtain energy savings, it is possible to pulse control the power supply to the evaporator fans.

Pulse control can be accomplished in one of the following ways:

- during the thermostat's cut-out period (cold room)
- during night operation and during the thermostat's cut-out period (appliance with night blinds)
(The function is not actual when r14=2, i.e. modulating regulation).

A period of time is set as well as the percentage of this period of time where the fans have to be operating.

Figure 24: Fan cycle time

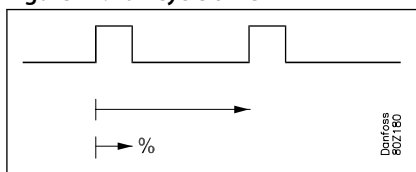

Cut-out of fans during plant breakdowns

If the refrigeration in a breakdown situation stops, the temperature in the cold room may rise quickly as a result of the emission of heat from large fans. In order to prevent this situation, the controller can stop the fans if the temperature at S5 exceeds a set limit value. The fans will start running again when the S5 temperature has dropped 2K below the set limit. (The function can also be used as a type of MOP function. Here the load on the compressors is limited until the S5 temperature has fallen below the configured value).

Fan ECO operation (only custom set-up)

Fan ECO operation is used to reduce fan speed during night operation – typically on cabinets with night blinds.

The function is enabled when a relay has been configured for Fan ECO function in one of the applications with custom set-up of relay functions.

The fan economy control (fan speed) is controlled via the two fan outputs:

- Fan output
- Fan Eco output

If the Fan output is activated, then the fan is running with 100% speed.

If the Fan ECO output is also activated, then the fan is running with reduced speed (typically 50%).

If both fan outputs are de-activated, then the fans are stopped.

Figure 25: Fan ECO control – Fan speed reduced to 50% during night operation

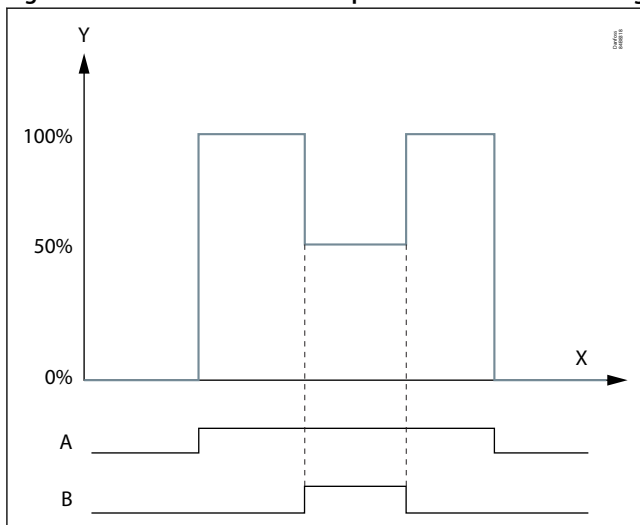

X	Time
Y	Fan speed
A	Fan
B	Fan ECO

The fans will always run with full speed during day operation, first stage of case cleaning, defrost, forced cooling and when air heating is active.

Light function

The function can be used for controlling the light in a refrigeration appliance or in a cold room. It can also be used for controlling a motorised night blind.

The light function can be defined in several ways:

1. The light is controlled via the day/night function. A digital input setup for light control can switch light ON, if the light is switched off during night
2. The light is controlled by a system manager via the parameter o39. A digital input setup for light control can switch light ON, if the light is switched off by the system manager.
3. Light is controlled via the door switch. Light is switched ON when door is opened and switched OFF 2 minutes after the door has been closed.
4. Like option 2, but here the light is switched ON automatically if the communication to the system manager has been lost for 15 minutes
5. Light is only controlled via a digital input setup for light control

The light load must be connected to the NC terminals on the relay.

This ensures that the light remains ON in the appliance if power to the controller should fail.

A setting defines how light is controlled when regulation is stopped via r12 Main switch = OFF (see o98). The light is switched off when the appliance cleaning function is activated.

Night blind

Motorised night blinds can be controlled automatically from the controller either through the custom set-up night blind output or via the NO connector on the light relay. The night blinds will follow the status of the light function. When the light is switched on, the night blinds open, and when the light is switched off, the night blinds close again. When the night blinds are closed, it is possible to open them using a switch signal on the digital input. If this pulse signal is activated, the night blinds will open and the refrigeration appliance can be filled with new products. If the pulse signal is activated again, the blinds close.

When the night blind function is used, the thermostat function can control with different weighting between the S3 and S4 sensors. A weighting during day operation and another when the blind is closed.

A night blind is opened when the appliance cleaning function is activated.

A setting can define that the night blind is opened when "r12" (Main switch) is set to off (see o98).

When the night blind rolls down, the fan will be stopped for the set time. The night blind can thereby roll down to the correct position.

Humidity control

In application 8 when setup for room control it is possible to define if humidity control should be done via a humidifier or a dehumidifier.

When humidity control is enabled, the second display will read out the actual humidity.

The controller measures the humidity via a 0 – 10 V signal from a humidity sensor and by means of a DO relay it can activate a humidifier or a de-humidifier.

High and low humidity alarm limits can be set to generate a humidity alarm.

Humidity control is disabled when main switch is OFF, at manual control, at case shutdown, at forced closing mode, at door open, if cooling is stopped, at humidity sensor error and at case cleaning.

It is possible to define whether humidity control is enabled during defrost or not.

Figure 26: Humidity control

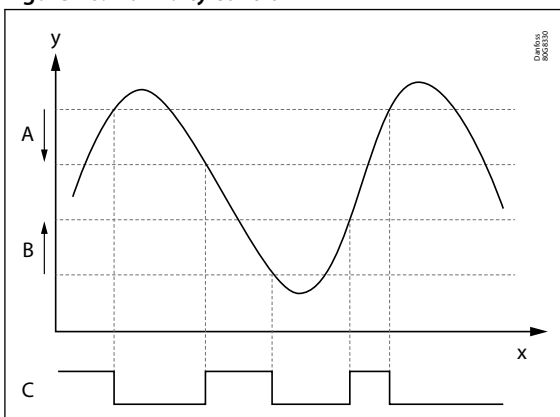

x	Time
y	Temperature
A	Humidity max temp. difference
B	Humidity min temp. difference
C	Humidity control enabled

A Max and Min temperature range can be defined wherein the humidity control is enabled. Upper and lower differential is fixed at 1K.

It can be defined whether humidity control is active during defrost or not.

Figure 27: Humidifier control

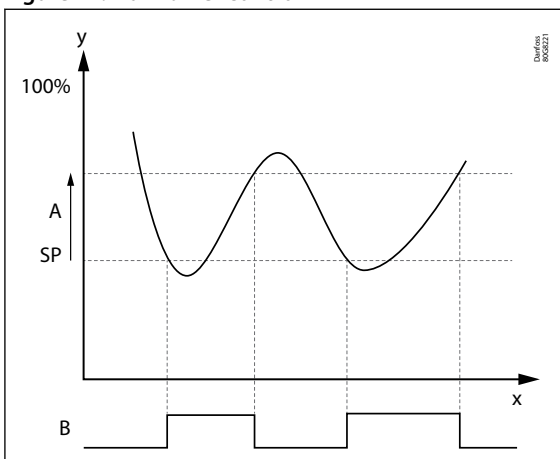

x	Time
y	Humidity
A	Humidity difference
SP	Setpoint
B	Humidifier

If the humidity gets below the SP, then humidification is started via a DO signal to a humidifier.

If the humidity increases to SP + humidity differential, then humidification is stopped.

Figure 28: Dehumidifier control

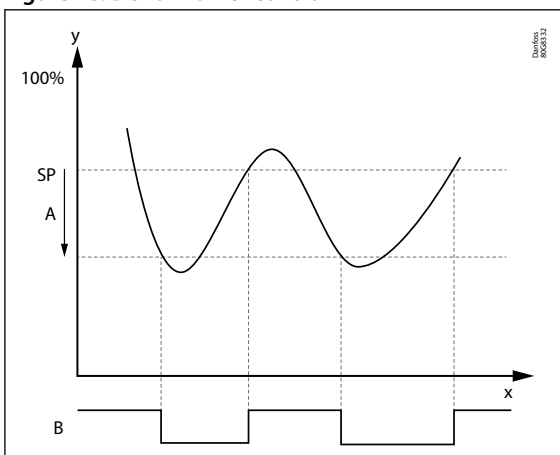

x	Time
y	Humidity
SP	Setpoint
A	Humidity difference
B	Dehumidifier

If the humidity rises above the SP, then dehumidification is started via a DO signal to a dehumidifier.

If the humidity drops below the SP - Humidity differential, then dehumidification is stopped.

Heating function (only with custom set-up)

The heating function is used to prevent the temperature from becoming too low, e.g. in a cold room, etc. The limit for when the heating function cuts off is set as an offset value below the current cut-out limit for the refrigeration thermostat. This ensures that refrigeration and heating do not occur simultaneously. The difference for the heating thermostat has the same value as for the refrigeration thermostat. To prevent that the heating thermostat cuts in during short-term drops in air temperature, a time delay can be set for when to change from refrigeration to heating.

Figure 29: Heating function

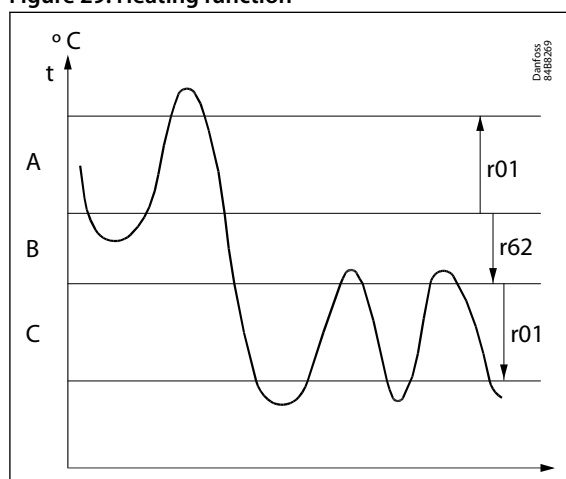

A	Refrigeration
B	Neutral zone
C	Heat

Digital inputs

There are two digital inputs, DI1 and DI2, with dry contact function, and one digital input DI3 with high voltage signal.

They can be used for the following functions:

Table 5: Function table and DI settings

Function	Input / Settings menu			Setting
	DI1	DI2	DI3	
	o02	o37	o84	
None	+	+	+	0
DI Status	+	+	+	1
Door function	+	+	+	2
Door alarm	+	+	+	3
Defrost start	+	+	+	4
Main switch	+	+	+	5
Night setback	+	+	+	6
Thermostat band	+	+	+	7
Alarm at closed	+	+		8
Alarm at open	+	+		9
Case cleaning	+	+	+	10
Forced cooling	+	+	+	11
Open blinds	+	+	+	12
Coordinated defrost		+		13
Forced closing	+	+	+	14
Shutdown	+	+	+	15
Light control	+	+	+	16
Leak detection	+	+	+	20
Adaptive liquid control	+	+	+	21
Valve driver alarm at open	+	+		22
Fan alarm at open	+	+		23
Door fan stop	+	+	+	29
Oil recovery	+	+	+	30

Example: If DI1 is to be used to start a defrost, o02 must be set to 4.

Forced closing

The AKV valves can be closed with an external signal ("Forced closing").

The function must be used in connection with the compressor's safety circuit, so that there will be no injection of liquid into the evaporator when the compressor is stopped by the safety controls and cannot start again (however not at low pressure – LP).

Via a setting (see o90 Fan at forced closing) it is possible to define whether the fan should be ON or OFF during forced closing and whether an ongoing defrost is suppressed (i.e. put in standby position for a period of up to 10 minutes before it is cancelled) - this feature can be used in CO₂ systems to eliminate excessive heating while compressors cannot run.

The signal can be received from the DI-input or via the data communication.

Door contact

The door contact function can via the digital inputs be defined for two different applications:

Alarm monitoring:

The controller monitors the door contact and delivers an alarm message if the door has been opened for a longer period than the set alarm delay.

Alarm monitoring and stop of refrigeration:

When the door is opened, the refrigeration is stopped, i.e. the injection, the compressor and the fan are stopped and light switches on. If the door remains open for a longer time than the set restart time, refrigeration will be resumed. This will ensure that refrigeration is maintained even if the door is left open or if the door contact should be defective. If the door remains open for a longer period than the set alarm delay, an alarm will also be triggered.

Alarm monitoring and stop of fans:

When the door is opened, only the fans are stopped. If the door remains open for a longer time than the set alarm delay, an alarm is triggered and the fans will start running again.

Display

The controller has one or two plugs for an external display.

One of the following display types can be connected to a plug:

- AK-UI55 Info (temperature display)
- AK-UI55 Set (temperature display and operation)
- AK-UI55 Bluetooth (temperature display and app interface)

The connection between the display and the controller must be made using an AK-UI55 cable.

The distance between the controller and the display must not exceed 100 m.

If there are two external displays, it will be the sum of the two distances that cannot exceed 100 m.

Figure 30: Controller with two displays

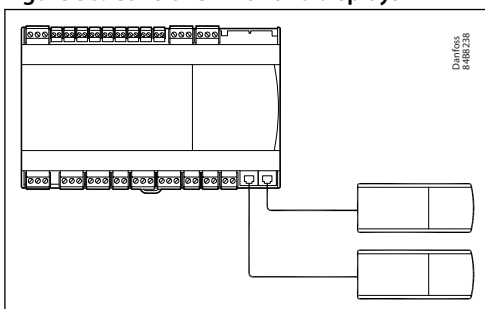

Override

The controller contains a number of override functions which can be used together with Master Control functions in the Danfoss gateway/system manager:

Table 6: Override functionality

Master control function	Description
MC Ther. toggle	Master control signal used for switching case load ON/OFF depending on the load condition
MC Load request	Master control signal used to control the load balance between multiple case controllers on the same suction line
MC Max. Te offset	Requested offset to actual evaporating temperature in order to keep the air temperature at the actual setpoint
MC Liquid control	Master control signal allowing switch to adaptive liquid control
MC Night setback	Master control signal for changing between day and night time operation
MC Case shutdown	Master control signal used to shut down a case for a time period. During shutdown there will be no alarm monitoring
MC Forced closing	Master control signal that will close the injection valve
MC Forced cooling	Master control signal that will provide forced cooling
MC Defrost start	Master control signal for starting a defrost. At adaptive defrost the defrost might be skipped if the defrost is not needed
MC Defrost state	Read out the actual state of the defrost
MC Hold after defrost	Master control signal used for co-ordinated defrost control to hold cabinets from returning to normal refrigeration after a defrost until all cabinets have terminated defrost
MC Stop defrost	Master control signal used to prevent a defrost start in a controller.
MC Request next defrost	Master control signal used by system manager to see if a controller is requesting that the next defrost has to be carried out
MC Light signal	Master control signal for control of light via a data communication signal from the system manager
MC Actual dewpoint	Master control signal sending the actual measured dewpoint from the system manager to the controller over the network.
MC Tc temp. mean	Master control signal distributing the condensing temperature signal to the case controllers that are using adaptive defrost. At trans-critical CO ₂ sites the receiver pressure is distributed to the case controllers. This function needs to be set up in the system manager.
MC Po load factor	Calculated load factor for the refrigerated appliance. Used for suction pressure optimization.
MC Key/Bluetooth lock	Master control signal that will lock down all Bluetooth data communication and optionally also lock the display keyboard (parameter P89)
MC Min. delta T	Required minimum delta temperature across evaporator (S3 - Te) in order to keep the air temperature at the actual setpoint
MC Oil Recovery	Master control signal used for starting and stopping an oil recovery sequence

Applications

The chapter outlines application examples:

- Standard display case
- Cases with one valve, one evaporator and two refrigeration sections
- Cases with one valve, two evaporators and two refrigeration sections
- Cold rooms

An application setting will configure inputs and outputs so that the controller's operation interface is reflecting the selected application.

In application 9, users can custom define the functions of relay 2 (DO1 is always AKV), e.g.:

- Controlling two compressors
- Controlling the night blind
- Controlling the heat function
- ECO operations of fans

Figure 31: Standard display case, upright or normal, with one evaporator

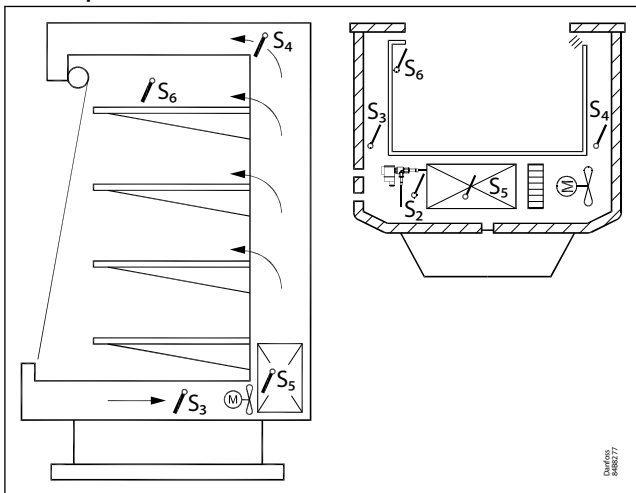

Figure 32: Back-to-back cabinet with one evaporator

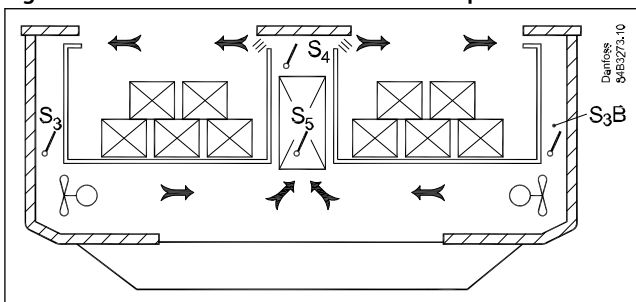
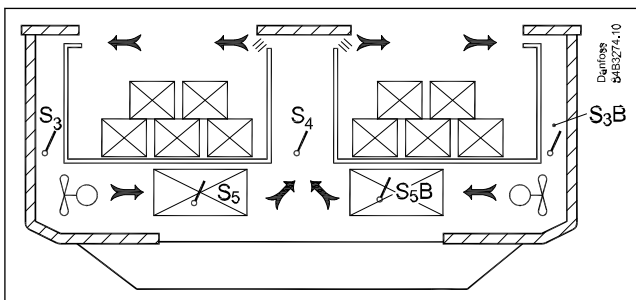
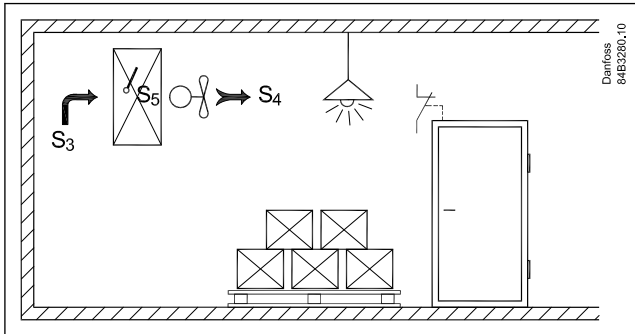

Figure 33: Back-to-back cabinet with two evaporators and one AKV valve



AK-CC55 Single Coil and AK-CC55 Single Coil UI

Figure 34: Cold room configuration with door and light heat control function



AK-CC55 connections and application options

Upper and lower connection labels are laid out as shown in figure:

Figure 35: Electrical connections AK-CC55 Single Coil

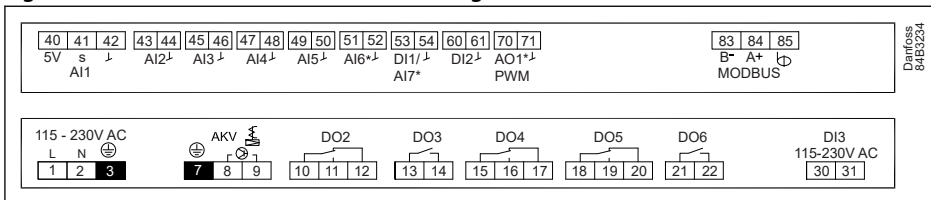

AK-CC55 Single Coil is optimised for control of one expansion valve + different combinations of light, rail heat and alarm relays. It has 6 Digital Outputs (DO), known as DO1 – DO6, one Analogue Output (AO), known as AO1, 6 Analogue Inputs (AI), known as AI1 – AI6, an input that can be used as either DI1 (Digital Input) or AI7 (Sensor Input), and 2 Digital Inputs, known as DI2 - DI3. AI7 (DI1) can be configured as S5B defrost sensor in application 1-6 and application 9.

DO1 will be configured for a liquid line solenoid valve if the analogue output AO1 is configured for control of a stepper valve driver.

Table 7: The controller covers the following nine applications:

Application 1-3	Plug-in cabinets. Cabinets with different output combinations of alarm, rail heat and light.
Application 4	Remote cabinet including alarm, rail heat, defrost, light and fan.
Application 5	Remote hot gas defrost with suction, drain and hot gas valve.
Application 6	Back-to-back cabinet with one evaporator.
Application 7	Back-to-back cabinet with two evaporators.
Application 8	Cold storage room with defrost and simple humidity control.
Application 9	Custom defined application, where the outputs can be configured according to custom requirements

Table 8: Application with digital and analogue output specification

No.	Application description	DO1	DO2	DO3	DO4	DO5	DO6	AO1
1	Plug-in cabinet							●
2	Plug-in cabinet							●
3	Plug-in cabinet							●
4	Remote cabinet							●
5	Remote Hot gas defrost		 (Suction)	 (Drain)	 (Hot gas)			●
6	Back-to-back cabinet							●
7	Back-to-back cabinet							●
8	Cold storage room			 humidity				●
9	User def. config.		User def.	User def.	User def.	User def.	User def.	●

● = Optional use

Table 9: Sensor description

Pe	Evaporating pressure
S2	Gas outlet of evaporator
S3	Return air temperature
S4	Discharge air temperature
S5	Evaporator temperature
S6	Product temperature
S3B	Return air temperature on second cooling section
S5B	Evaporator temperature on second evaporator or extra evaporator sensor on single evaporator
RH%	Relative humidity sensor

Table 10: Application with digital and analogue output specification

No.	Application description	AI1	AI2	AI3	AI4	AI5	AI6	AI7/DI1	DI2	DI3
1	Plug-in cabinet	Pe	S2	S3	S4	S5	S6	●	●	●
2	Plug-in cabinet	Pe	S2	S3	S4	S5	S6	●	●	●
3	Plug-in cabinet	Pe	S2	S3	S4	S5	S6	●	●	●
4	Remote cabinet	Pe	S2	S3	S4	S5	S6	●	●	●
5	Remote Hot gas defrost	Pe	S2	S3	S4	S5	S6	●	●	●
6	Back-to-back cabinet	Pe	S2	S3	S4	S5	S3B	●	●	●
7	Back-to-back cabinet	Pe	S2	S3	S4	S5	S3B	S5B	●	●
8	Cold storage room	Pe	S2	S3	S4	S5	S6	RH%	●	●
9	User def. config.	Pe	S2	S3	S4	S5	S6	●	●	●

● = Optional use

Application set-ups and IO connections

Figure 36: Connections for application 1

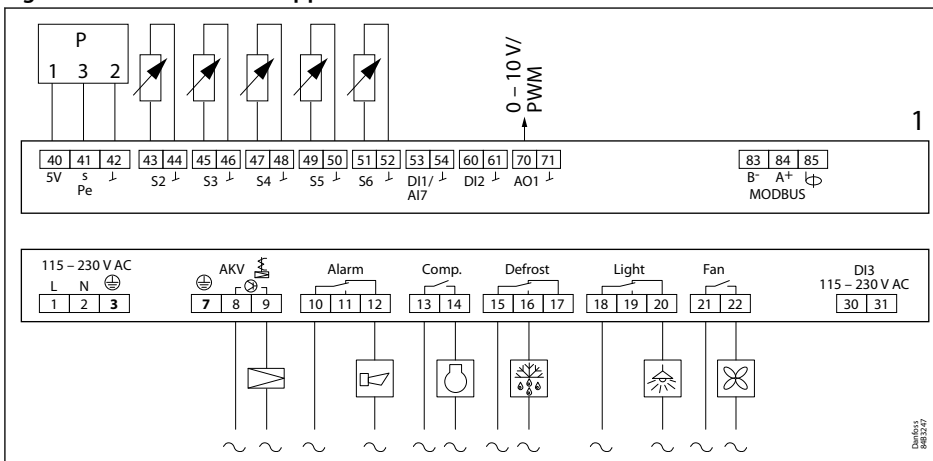

AK-CC55 Single Coil and AK-CC55 Single Coil UI

Figure 37: Connections for application 2

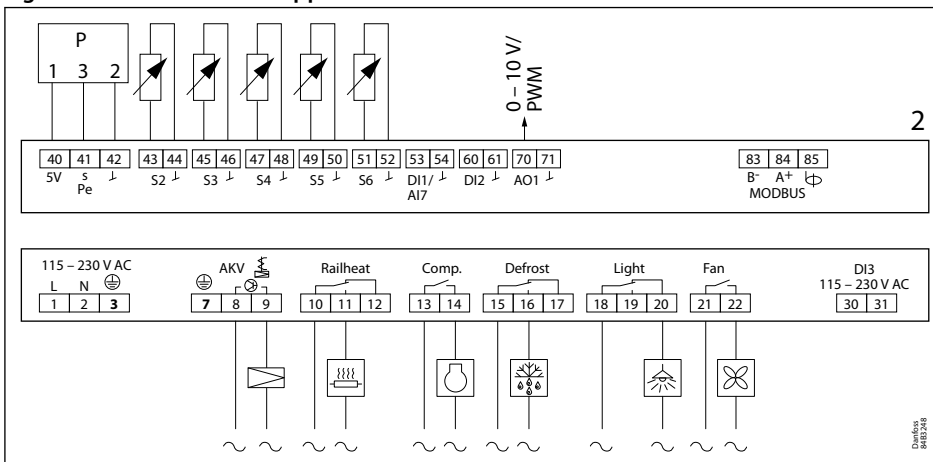

Figure 38: Connections for application 3

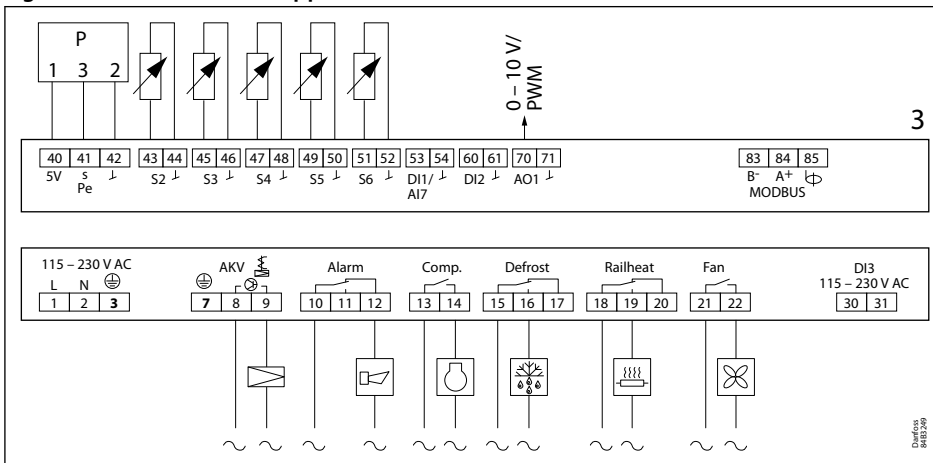
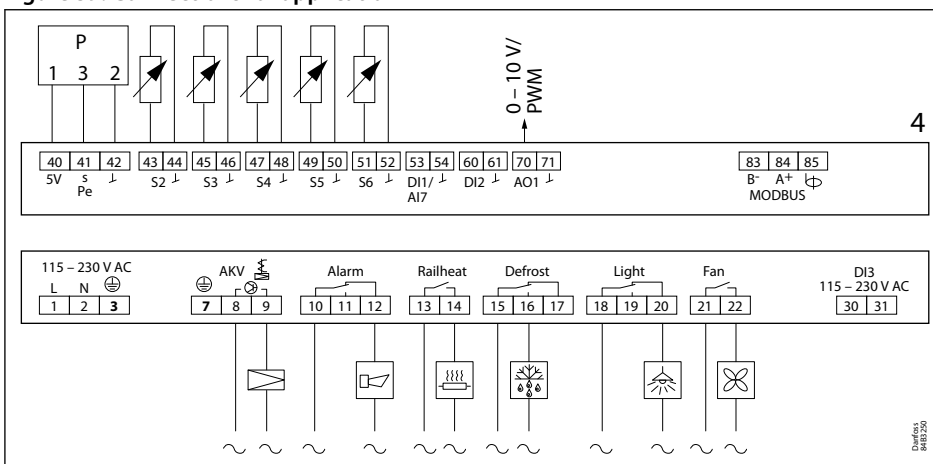

Figure 39: Connections for application 4



AK-CC55 Single Coil and AK-CC55 Single Coil UI

Figure 40: Connections for application 5

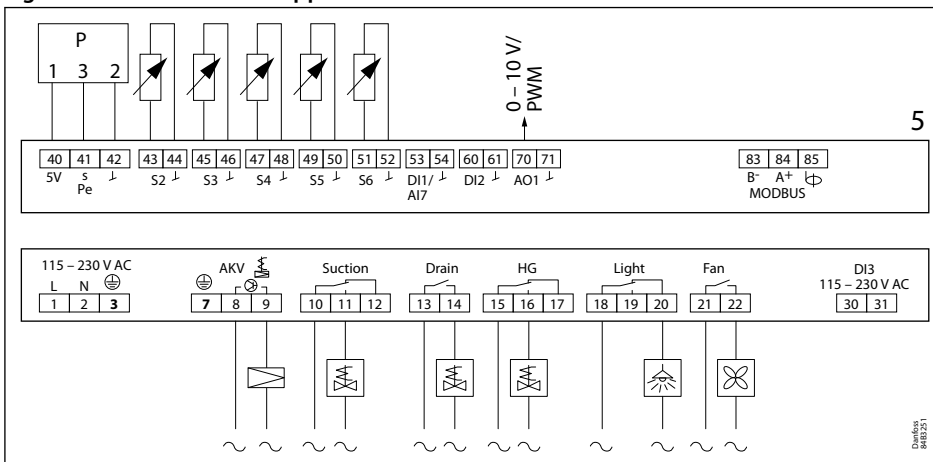

Figure 41: Connections for application 6

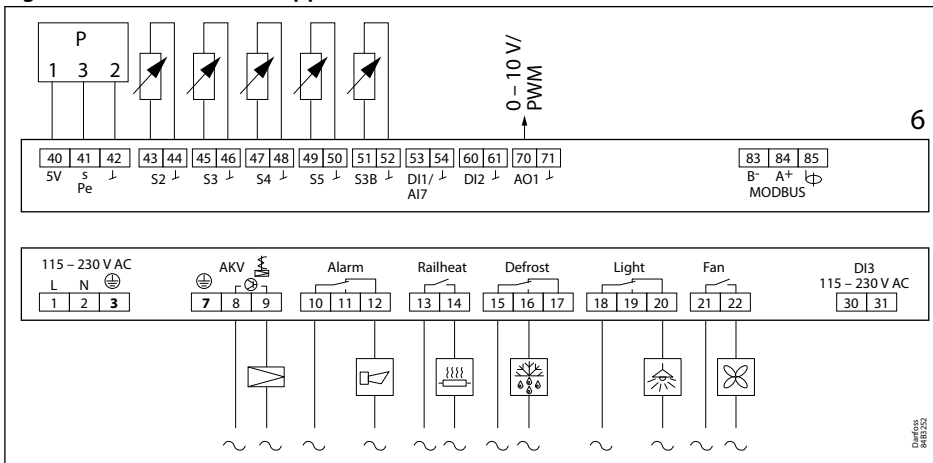

Figure 42: Connections for application 7

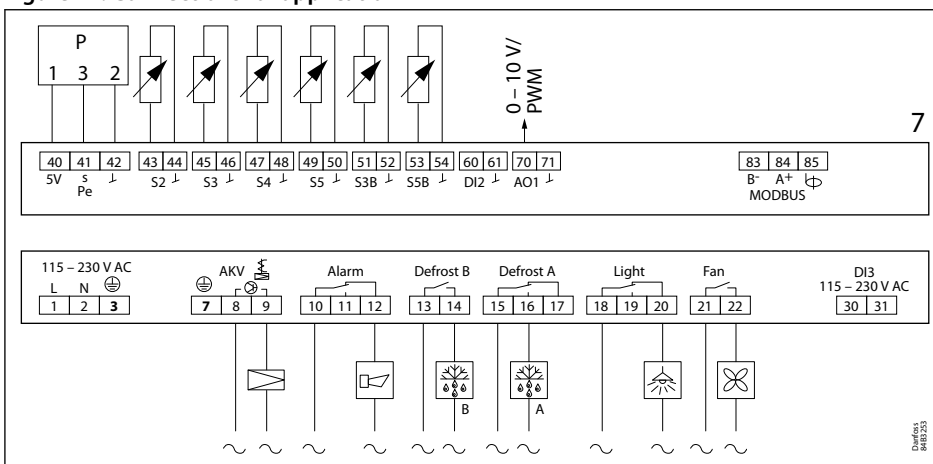

Figure 43: Connections for application 8

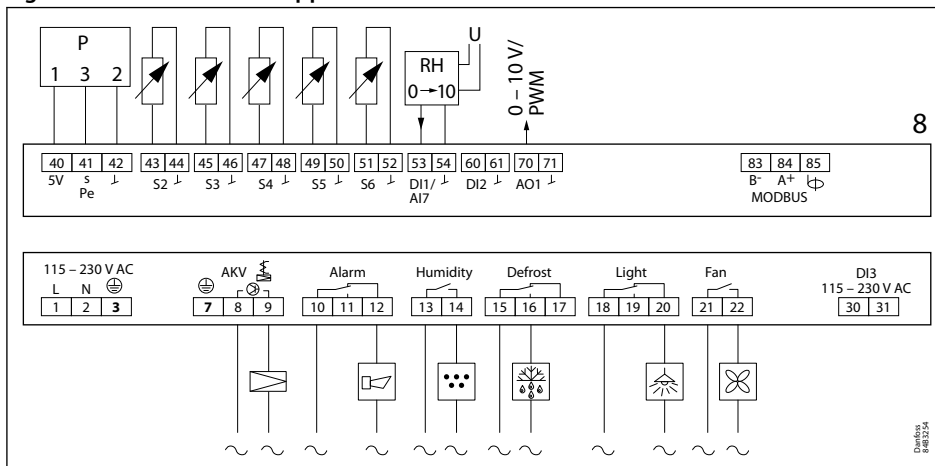
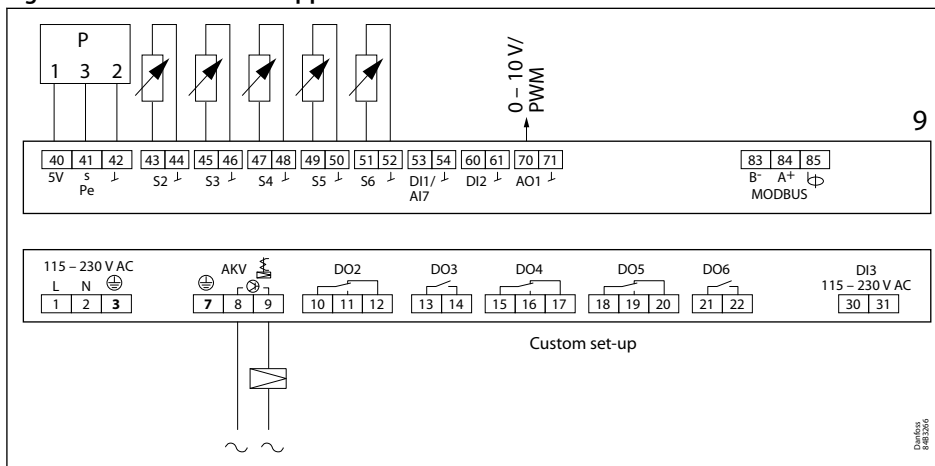

Figure 44: Connections for application 9



Product identification

The controller is provided with labels from the factory, indicating a generic application. When selecting the required application, specific labels are provided so that you can mount the relevant one.

The application number is indicated on the left-hand side of the labels. Use the label fitting the selected application.

Some of the labels are applicable to multiple application options.

Figure 45: Product identification

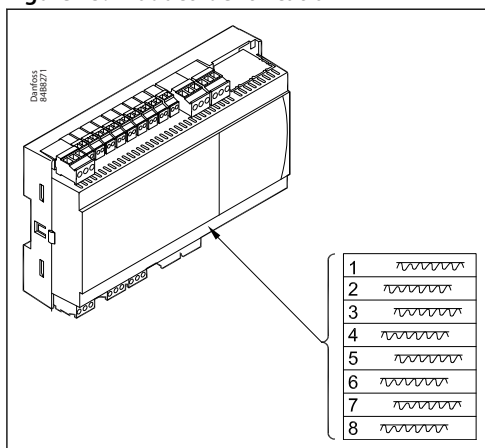

AK-CC55 Single Coil connections

Data communication

Figure 46: Data communication

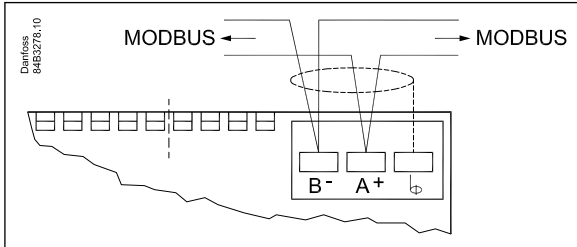

IMPORTANT:

It is important that the installation of the data communication cable is performed correctly with sufficient distance to high voltage cables.

AKV info

Figure 47: AKV info

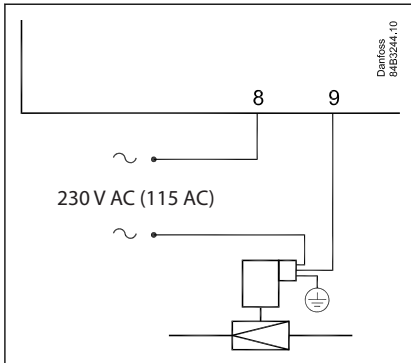

230 V or 115 V
AC coil
Max. 0.5 A

External solid state relay for rail heat

Figure 48: External solid state relay for rail heat

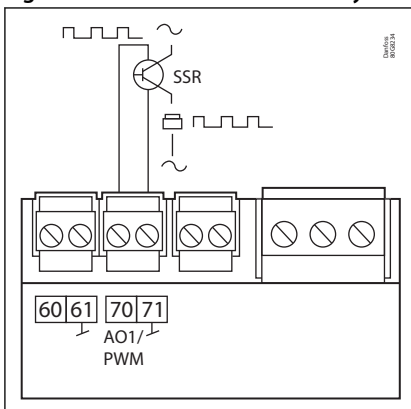

0 / 10 V Pulse Width Modulated (PWM)
Max. 15 mA.

AKS 32R info

Figure 49: AKS 32R info

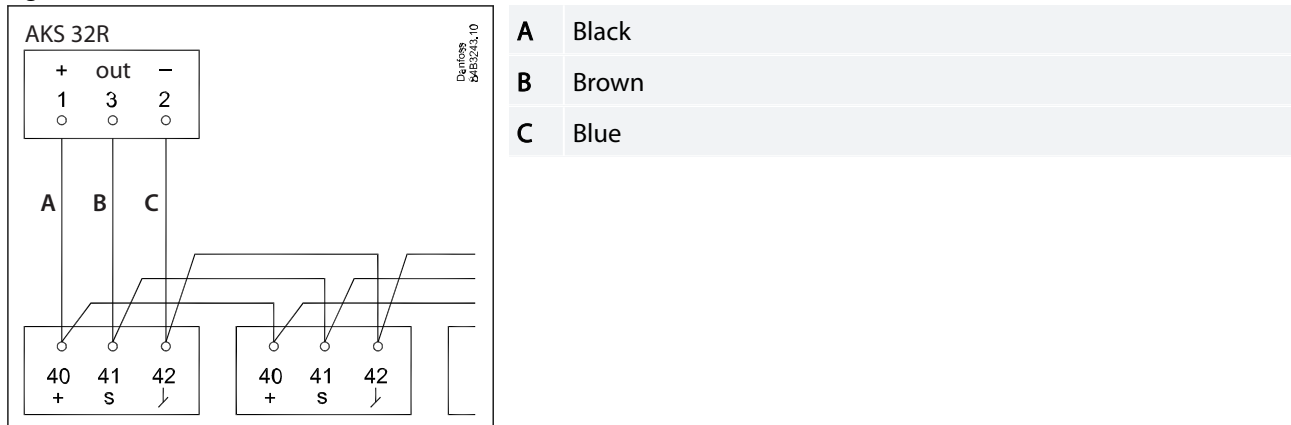

NOTE:

A ratiometric pressure transmitter with a 5 V, 10 – 90% voltage output signal must be used.

The signal from one pressure transmitter can be received by up to 10 controllers. There must not be a significant pressure drop from the pressure transmitter's position in the suction line to the individual evaporators.

Coordinated defrost via cable connections

Figure 50: Coordinated defrost via cable connections

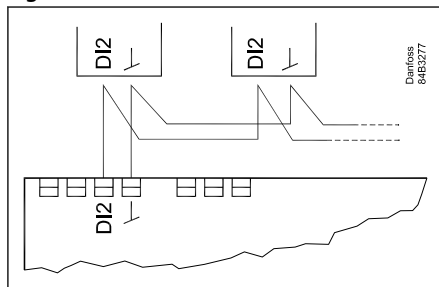

Max. 10

The following controllers can be connected in this way:

EKC 204A, AK-CC 210, AK-CC 250, AK-CC 450, AK-CC 550 and AK-CC55.

Refrigeration is resumed at the same time when all controllers have terminated defrost.

External display AK-UI55

Figure 51: External display AK-UI55

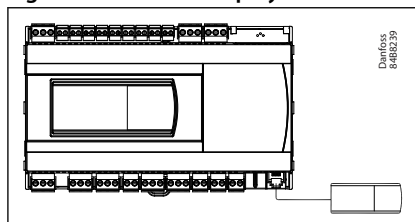

Display

084B4075 / 084B4076 / 084B4077

Cable 3 m: 084B4078

Cable 6 m: 084B4079

(Total length: max. 100 m)

Connections

Table 11: Connection details

AI1	<p>Pressure transmitter AKS 32R Connect to terminal 40, 41 and 42. (Use cable 060G1034: Black=40, Brown=41, Blue=42)</p> <p>The signal from one pressure transmitter can be received by up to 10 controllers. But only if there are no significant pressure drops between the evaporators to be controlled. See Figure 49: AKS 32R info.</p> <p>NOTE: When replacing AK-CC 550 with AK-CC55, S and ground must be switched.</p>
AI2 - AI7	<p>Primarily for temperature inputs</p> <ul style="list-style-type: none"> S2 Pt 1000 ohm sensor AKS11, placed at the evaporator outlet S3, S4, S5 Pt 1000 AKS11, PTC 1000 EKS111, NTC5K EKS211, NTC10K EKS221 or a user-defined sensor type. All have to be of the same type. S3, return air sensor, placed in the warm air before the evaporator S4, discharge air sensor, placed in the cold air after the evaporator (the need for either S3 or S4 can be selected in the configuration) S5, defrost sensor, placed in the evaporator S6, Pt 1000 ohm sensor, food temperature sensor placed in-between the food products (If the DI1 input is used for a temperature measurement e.g. S5B, it will appear as AI7.)
DI1	<p>Digital input signal The defined function is active when the input is short-circuited or opened, depending on the function defined in o02.</p>
DI2	<p>Digital input signal The defined function is active when the input is short-circuited or opened, depending on the function defined in o37.</p>
AO1	<p>Analogue output signal</p> <ul style="list-style-type: none"> Analogue 0 – 10 V Can be used to drive an external stepper driver. Pulse width modulated signal Can be used for fast pulse control of rail heat via an external power solid state relay.
MODBUS	<p>For data communication:</p> <ul style="list-style-type: none"> Terminal 83 = B- Terminal 84 = A+ Terminal 85 = screen <p>NOTE: When replacing AK-CC 550 with AK-CC55 A+, B- and shield must be switched.</p>
Supply voltage	230 V AC or 115 V AC
DO1	<ul style="list-style-type: none"> AKV valve Connection of expansion valve type AKV, AKVA, AKVH or AKVP. The coil must be a 230 V or 115 V AC coil. Liquid line solenoid valve Connection of normally closed valve in connection with stepper valve.
DO2	<ul style="list-style-type: none"> Alarm There is a connection between terminal 10 and 12 in alarm situations and when the controller is without power. DO2 has reinforced insulation that can be used with 24 V. Light, Rail heat, Compressor, Night blind There is connection between terminal 10 and 11 (10 and 12 at light) when the function is on. Suction line valve There is connection between terminal 10 and 11 when the suction line must be open.
DO3	<ul style="list-style-type: none"> Compressor, Rail heat, Defrost, Drain valve, Humidity There is connection between terminal 13 and 14 when the function must be active.
DO4	<ul style="list-style-type: none"> Defrost There is connection between terminal 15 and 16 when defrosting takes place. Hot gas There is connection between terminal 15 and 16 when the hot gas valves must open. <p>NOTE: When replacing AK-CC 550 with AK-CC55, wires must be switched.</p>
DO5	<ul style="list-style-type: none"> Light There is connection between terminal 18 and 20 when the function must be active. Rail heat There is connection between terminal 18 and 19 when the rail heat must be on.
DO6	<ul style="list-style-type: none"> Fan There is connection between terminal 21 and 22 when the fan is on.
DO2-DO6 + AO1 and Application 9	Here, the different outputs can be custom defined in q02-q09
DI3	<p>Digital input signal The signal must have a voltage of 0 / 230 V AC (115 V AC) The function is defined in o84.</p>

Display (RJ12 plug)

If external readings/operation of the controller is required, a display can be connected. If there is no display on the front, two external displays can be connected. For one display the max. cable length is 100 m. For two displays the sum of the two cable lengths must not exceed 100 m.

i NOTE:

When replacing AK-CC 550 with AK-CC55, AKA 16X remote displays and cables have to be replaced with new AK-UI55 displays and cables.

Electric noise

Cables for sensors, low voltage DI inputs and data communication must be kept separate from other high voltage cables:

- Use separate cable trays
- Keep a distance between cables of at least 10 cm
- Long cables at the low voltage DI input should be avoided

Installation considerations

Accidental damage, poor installation, or site conditions, can give rise to malfunctions of the control system, and ultimately lead to a plant breakdown.

Every possible safeguard is incorporated into our products to prevent this. However, a wrong installation could still present problems. Electronic controls are no substitute for normal, good engineering practice.

Danfoss will not be responsible for any goods, or plant components, damaged as a result of the above defects. It is the installer's responsibility to check the installation thoroughly, and to fit the necessary safety devices.

Special reference is made to the necessity of signals to the controller when the compressor is stopped and to the need of liquid receivers before the compressors.

Your local Danfoss agent will be pleased to assist with further advice, etc.

Replacing AK-CC 550 with AK-CC55

i NOTE:

Be aware when exchanging an AK-CC 550 controller with a new AK-CC55 controller - new wiring principles!

Table 12: Replacing AK-CC 550 with AK-CC55

	AK-CC 550	AK-CC55
Pressure sensor has new connection – signal and ground are switched		
SPDT relays have a new wiring scheme – NO and NC terminals are switched (e.g. defrost heater on when it should be off)		
Modbus has new connection scheme (A,B and screen)		
New AK-UI55 displays and cables with 6 wires vs. 3 wires for EKA 16x		

- AK-CC55 does not support two EEC coils connected to one AKV output.
- Pressure transmitter can be shared between AK-CC 550 and AK-CC55.
- DI2 defrost coordination can be wired between AK-CC 550 and AK-CC55.

Operation

The controller can be operated in different ways depending on the user interface.

The following options are available:

- Via data communication
- Via AK-UI55 Setting Display
- Via AK-UI55 Bluetooth display

Operation via data communication

Via system manager's display

All AK-CC55 controllers can be operated from a central location, e.g. AK-SM 800.

Data communication is to take place via MODBUS or Lon.

Via system manager and service tool

Operation can also be performed from a central location with PC software "Service Tool" connected to a system manager AK-SM 720 via MODBUS or Lon.

Programming via KoolProg

Programming by use of PC software type KoolProg® via interface MMIMYK connected to RJ12 display connector.

Direct operation

Operation via AK-UI55 setting display

The display can be located on the front of the controller or at a distance of up to 100 metres from the controller.

Smart phone and app via AK-UI55 Bluetooth display

The "AK-CC55 connect" app is used for smart phone operation.

AK-CC55 connect can be downloaded freely to a compatible iOS/Android smartphone device.

The display can be placed at a distance of up to 100 metres from the controller.

Menu operation is established by activating Bluetooth communication to the app.

Operation via AK-UI55 Set

Display AK-UI55 Set

The values will be shown with three digits, and with a setting you can determine whether the temperature is to be shown in °C or in °F.

To prevent any passing-by user from making unauthorized changes, the access to the display menu is restricted by access codes.

Besides this, the parameter P89 provides the following options for handling of the display keyboard:

0	The display keys are always operative
1	The display keys will be locked automatically when not used for some time and the keyboard must be unlocked by pressing the arrow-up and arrow-down keys at the same time.
2	The display keys will be locked and unlocked by means of a master control signal from the System Manager.

Figure 52: Operating via AK-UI55 Set

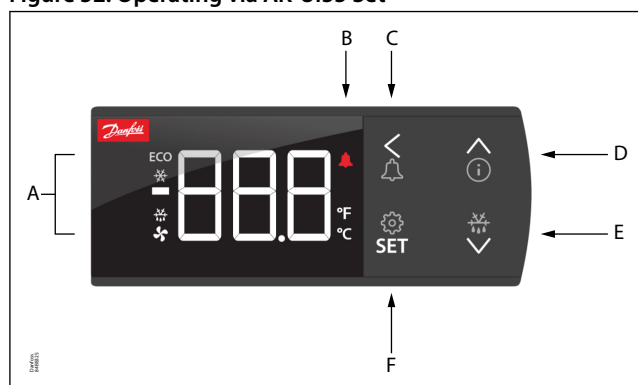

A	Lights up in event of: Energy optimization, Cooling, Defrosting, Fan operation	E	Long press (3 seconds) will start a defrost, “-d-” is shown in the display. Ongoing defrosting can be stopped by a long press.
B	Lights in event of alarm	F	SET: Long press (3 seconds) gives access to the “SEt” menu. If the operation is locked with a password, “PS” is shown. Enter the code. Shows the setting for a chosen parameter / saves a changed setting. Short press gives access to entering of the thermostat’s cut-out limit.
C	Long press (3 seconds) on alarm button alarm — relay is reset — alarm code displayed — e.g. “A1”		
D	Long press (3 seconds) gives access to the information menu “InF” Up arrow / Down arrow / Arrow to left: Navigation in the menu and setting of values.		

Table 13: Messages provided by the display

Display readout	Denomination
-d-	Defrost is in progress
Err	The temperature cannot be displayed due to a sensor error
Err1	The display cannot load data from the controller. Disconnect and then reconnect the display
Err2	Lost display communication
ALA	The alarm button is activated. The first alarm code is then shown
---	At top position of the menu or when max. value has been reached, the three dashes are shown in the top of the display
---	At bottom position of menu or when min. value has been reached, the three dashes are shown in the bottom of the display
Loc	The menu operation is locked. Unlock by pressing (for 3 seconds) on the ‘up arrow’ and ‘down arrow’ simultaneously
UnL	The menu operation is unlocked
---	The parameter has reached min. or max. limit
PS	A password is required for access to the menu
Fan	Appliance cleaning has been initiated. The fans are running
OFF	Appliance cleaning is activated and the appliance can now be cleaned
OFF	The main switch is set to Off
SEr	The main switch is set to service / manual operation
CO2	Flashes: Will display in event of a refrigerant leakage alarm, but only if the refrigerant is set up for CO ₂

Factory setting

If you need to return to the factory-set values, do the following:

- Cut off the supply voltage to the controller
- Keep up “^” and down “v” arrow buttons depressed at the same time as you reconnect the supply voltage
- When FAc is shown in the display, select “yes”

i NOTE:

The OEM factory setting will either be the Danfoss factory settings or a user defined factory setting if one has been made.

The user can save his setting as OEM factory setting via parameter o67.

Parameter groups when operating via display

Figure 53: SET button parameter list

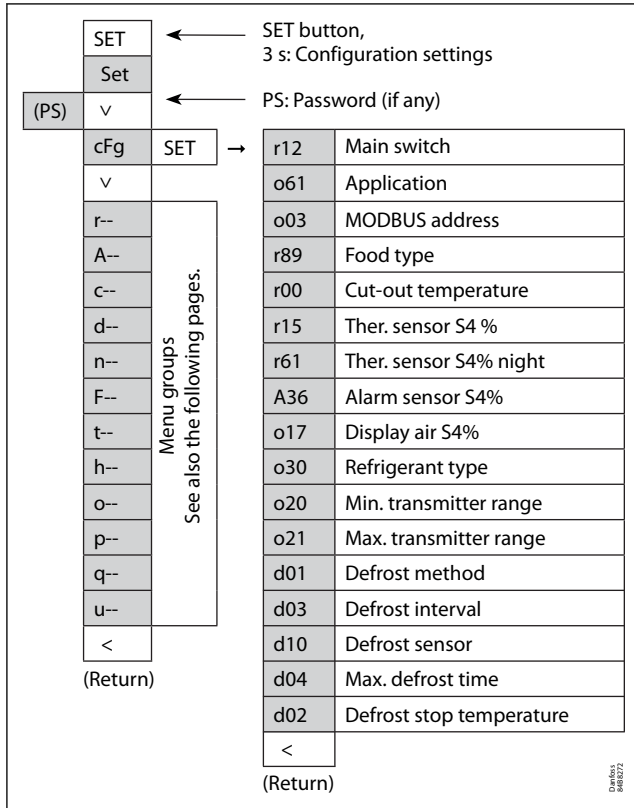
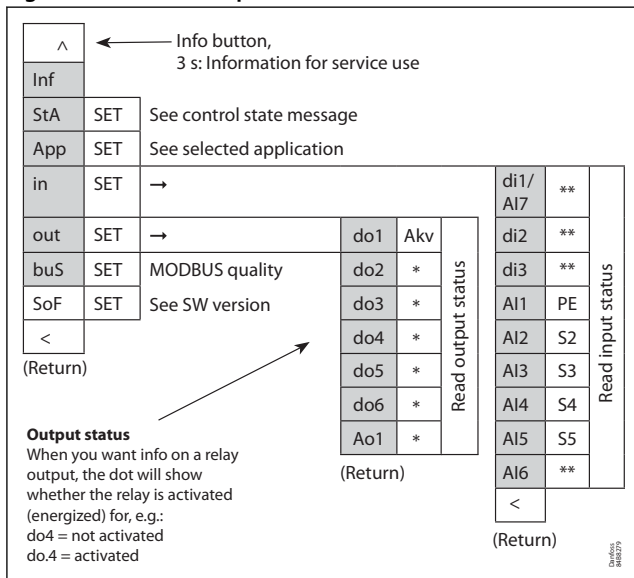

Figure 54: Info button parameter list



- * The output's function (determined at configuration). The DOs and AOs can also be forced controlled from this menu, when r12 Main switch has been set in position "service". Forced control of a function can also be performed in codes q11 to q27.
- ** The input's function (determined at configuration).
- StA See control state message in [Table 49](#)

Get a good start

With the following procedure you can start regulation very quickly:

1. Open parameter r12 and stop the regulation (in a new and not previously set unit, r12 will already be set to 0 which means stopped regulation)
2. Select application based on the wiring diagrams on [Page 31](#)
3. Open parameter o61 and set the application number
4. For network. Set the address in o03
5. Then select a set of presets from the "Food type" help table

6. Open parameter r89 and set the number for the array of presets. The few selected settings will now be transferred to the menu
7. Set the desired cut-out temperature r00
8. Set the weighted thermostat air temperature between S4 and S3 sensor r15
9. Set the weighted thermostat air temperature between S4 and S3 during night operation r61
10. Set the weighted alarm air temperature between S4 and S3 A36
11. Set the weighted display readout between S4 and S3 o17
12. Select refrigerant via parameter o30
13. Set the pressure transmitter min. and max. range via parameter o20 and o21
14. Set the desired defrost method in d01
15. Set the interval time between defrost starts in d03
16. Set the desired defrost sensor in d10
17. Set the maximum defrost time in d04
18. Set the defrost stop temperature in d02
19. Open parameter r12 and start the regulation
20. Go through the parameter list and change the factory values where needed
21. Get the controller up and running on network:
 - MODBUS: Activate scan function in system unit
 - If another data communication card is used in the controller:
 - Lon RS485: Activate the function o04
 - Ethernet: Use the MAC address

Table 14: Food type settings

Setting of presets (r89). After setting 1-5, setting is returned to 0.	1	2	3	4	5
Food type	Vegetables	Milk	Meat/fish	Frozen food	Ice cream
Temperature (r00)	8 °C	0 °C	-2 °C	-20 °C	-24 °C
Max. temp. setting (r02)	10 °C	4 °C	2 °C	-16 °C	-20 °C
Min. temp. setting (r03)	4 °C	-4 °C	-6 °C	-24 °C	-28 °C
Upper alarm limit (A13)	14 °C	8 °C	8 °C	-15 °C	-15 °C
Lower alarm limit (A14)	0 °C	-5 °C	-5 °C	-30 °C	-30 °C
Upper alarm limit for S6 (A22)	14 °C	8 °C	8 °C	-15 °C	-15 °C
Lower alarm limit for S6 (A23)	0 °C	-5 °C	-5 °C	-30 °C	-30 °C

AK-UI55 display menu (SW ver. 1.7x)

R-W	If the operation is protected by one or more passwords, reading and setting the parameter will be limited to: R or W
R	This setting can be seen with password no. _ or higher (3 is the highest level).
W	This setting can be performed with password no. _ or higher (3 is the highest level).
*	The asterisk indicates in which application from 1-9 the parameter is applicable.

Thermostat
Table 15: Thermostat

Function	Values	R-W	Code	1	2	3	4	5	6	7	8	9	Min. value	Max. value	Fact. value
Cut-out 1		0-0	r00	*	*	*	*	*	*	*	*	*	r03	r02	2.0 °C
Differential 1		1-2	r01	*	*	*	*	*	*	*	*	*	0.1 °C	20.0 °C	2.0 °C
Max cut-out limit		0-2	r02	*	*	*	*	*	*	*	*	*	r03	50.0 °C	50.0 °C
Min cut-out limit		0-2	r03	*	*	*	*	*	*	*	*	*	-60.0 °C	r02	-60.0 °C
Display readout adjustment		1-2	r04	*	*	*	*	*	*	*	*	*	-10.0 °C	10.0 °C	0.0 °C
Temperature unit	0=Celsius, 1=Fahrenheit	1-2	r05	*	*	*	*	*	*	*	*	*	0	1	0
S4 Air OFF evap. A - Adjustment		1-2	r09	*	*	*	*	*	*	*	*	*	-10.0 °C	10.0 °C	0.0 °C
S3 Air ON evap. A - Adjustment		1-2	r10	*	*	*	*	*	*	*	*	*	-10.0 °C	10.0 °C	0.0 °C
S5 Evaporator A - Adjustment		1-2	r11	*	*	*	*	*	*	*	*	*	-10.0 °C	10.0 °C	0.0 °C
Main switch	-1=Manual, 0=Stop, 1=Start	0-2	r12	*	*	*	*	*	*	*	*	*	-1	1	0
Night offset		1-2	r13	*	*	*	*	*	*	*	*	*	-50.0 °C	50.0 °C	0.0 °C
Thermostat mode	1=ON/OFF, 2=Modulating	1-2	r14	*	*	*	*	*	*	*	*	*	1	2	1
Thermostat sensor S4 %		1-2	r15	*	*	*	*	*	*	*	*	*	0 %	100 %	100%
Melt interval		1-2	r16	*	*	*	*	*	*	*	*	*	0 h	10 h	1 h
Melt period		1-2	r17	*	*	*	*	*	*	*	*	*	0 min	30 min	5 min
S2 Gas outlet A - Adjustment		1-2	r19	*	*	*	*	*	*	*	*	*	-10.0 °C	10.0 °C	0.0 °C
Cut-out 2		0-2	r21	*	*	*	*	*	*	*	*	*	-60.0 °C	50.0 °C	2.0 °C
S3 Air ON evap. B - Adjustment		1-2	r53						*	*			-10.0 °C	10.0 °C	0.0 °C
S6 product temp. - Adjustment		1-2	r59	*	*	*	*	*			*	*	-10.0 °C	10.0 °C	0.0 °C
Thermostat sensor S4 % night		1-2	r61	*	*	*	*	*	*	*	*	*	0 %	100 %	100%
Air heater neutral zone		1-2	r62									*	0.0 °C	50.0 °C	5.0 °C
Air heater start delay		1-2	r63									*	0 min	240 min	240 min
Food type	0=None, 1=Vegetables, 2=Dairy, 3=Meat and fish, 4=Frozen food, 5=Ice cream	1-2 ⁽¹⁾	r89	*	*	*	*	*	*	*	*	*	0	5	0
Differential 2		1-2	r93	*	*	*	*	*	*	*	*	*	0.1 °C	20.0 °C	2.0 °C
S4 frost protection		1-2	r98	*	*	*	*	*	*	*	*	*	-60.0 °C	50.0 °C	-60.0 °C

⁽¹⁾ In order to change this parameter the regulation must be stopped via the parameter r12 Main switch = OFF.

Alarm settings
Table 16: Alarm settings

Function	Values	R-W	Code	1	2	3	4	5	6	7	8	9	Min. value	Max. value	Fact. value
Alarm delay A		1-2	A03	*	*	*	*	*	*	*	*	*	0 min	240 min	30 min
Door open alarm delay		1-2	A04	*	*	*	*	*	*	*	*	*	0 min	240 min	60 min
Alarm delay pull down A		1-2	A12	*	*	*	*	*	*	*	*	*	0 min	240 min	90 min

AK-CC55 Single Coil and AK-CC55 Single Coil UI

Function	Values	R-W	Code	1	2	3	4	5	6	7	8	9	Min. value	Max. value	Fact. value
High alarm limit 1		1-2	A13	*	*	*	*	*	*	*	*	*	-60.0 °C	50.0 °C	8.0 °C
Low alarm limit 1		1-2	A14	*	*	*	*	*	*	*	*	*	-60.0 °C	50.0 °C	-30.0 °C
High alarm limit 2		1-2	A20	*	*	*	*	*	*	*	*	*	-60.0 °C	50.0 °C	8.0 °C
Low alarm limit 2		1-2	A21	*	*	*	*	*	*	*	*	*	-60.0 °C	50.0 °C	-30.0 °C
S6 High alarm limit 1		1-2	A22	*	*	*	*	*				*	-60.0 °C	50.0 °C	8.0 °C
S6 Low alarm limit 1		1-2	A23	*	*	*	*	*				*	-60.0 °C	50.0 °C	-30.0 °C
S6 High alarm limit 2		1-2	A24	*	*	*	*	*				*	-60.0 °C	50.0 °C	8.0 °C
S6 Low alarm limit 2		1-2	A25	*	*	*	*	*				*	-60.0 °C	50.0 °C	-30.0 °C
S6 alarm delay		1-2	A26	*	*	*	*	*				*	0 min	240 min	60 min
Alarm delay DI 1		1-2	A27	*	*	*	*	*	*			*	0 min	240 min	30 min
Alarm delay DI 2		1-2	A28	*	*	*	*	*	*	*		*	0 min	240 min	30 min
Alarm sensor S4% A		1-2	A36	*	*	*	*	*	*	*	*	*	0 %	100 %	100%
S6 alarm pull down delay		1-2	A52	*	*	*	*	*				*	0 min	240 min	90 min
Alarm delay B		1-2	A53						*	*			0 min	240 min	30 min
Use product sensor S6	0=No, 1=Yes	1-2 ⁽¹⁾	a01	*	*	*	*	*				*	0	1	0

⁽¹⁾ In order to change this parameter the regulation must be stopped via the parameter r12 Main switch = OFF.

Compressor

Table 17: Compressor

Function	Values	R-W	Code	1	2	3	4	5	6	7	8	9	Min. value	Max. value	Fact. value
Min ON time		1-2	c01	*	*	*						*	0 min	30 min	0 min
Min OFF time		1-2	c02	*	*	*						*	0 min	30 min	0 min
Delay between comp.		1-2	c05									*	0 s	999 s	5 s
Step control mode	1=Sequential, 2=Cyclic	1-2	c08									*	1	2	2
Comp. 2 ctrl. Th. band 2	0=OFF, 1=ON	1-2	c85									*	0	1	1

Defrost

Table 18: Defrost

Function	Values	R-W	Code	1	2	3	4	5	6	7	8	9	Min. value	Max. value	Fact. value
Defrost method	0=None, 1=Electrical, 2=Hot gas, 4=Air/Offcycle	1-3	d01	*	*	*	*	*	*	*	*	*	0	4	1
Defrost stop limit 1		1-2	d02	*	*	*	*	*	*	*	*	*	0.0 °C	50.0 °C	6.0 °C
Defrost start interval		1-2	d03	*	*	*	*	*	*	*	*	*	0 h	240 h	8 h
Max. defrost time 1		1-2	d04	*	*	*	*	*	*	*	*	*	0 min	360 min	45 min
Time staggering power-up		1-2	d05	*	*	*	*	*	*	*	*	*	0 min	240 min	0 min
Drip off time		1-2	d06	*	*	*	*	*	*	*	*	*	0 min	60 min	0 min
Fan start delay		1-2	d07	*	*	*	*	*	*	*	*	*	0 min	60 min	0 min
Fan start temperature		1-2	d08	*	*	*	*	*	*	*	*	*	-60.0 °C	10.0 °C	-5.0 °C
Fan control during defrost	0=OFF, 1=ON, 2=OFF at drip, 3=OFF at high temp	1-2	d09	*	*	*	*	*	*	*	*	*	0	3	1
Defrost stop method	0=Time, 1=S5 sensor, 2=S4 sensor, 3=S5A and S5B	1-2	d10	*	*	*	*	*	*	*	*	*	0	3	0
Pump down delay		1-2	d16	*	*	*	*	*	*	*	*	*	0 min	60 min	0 min
Drain delay		1-2	d17					*					0 min	60 min	0 min
Max. thermostat run time		1-2	d18	*	*	*	*	*	*	*	*	*	0 h	240 h	0 h
Adaptive defrost mode	0=OFF, 1=Monitoring, 2=Skip day, 3=Skip day/night, 4=Full adaptive	1-2 ⁽¹⁾	d21	*	*	*	*	*	*	*	*	*	0	4	0
Hot gas injection delay		1-2	d23					*					0 min	60 min	0 min
Min. defrost time		1-2	d24	*	*	*	*	*	*	*	*	*	0 min	d04	0 min
Rail heat during defrost	0=OFF, 1=ON, 2=Normal control	1-2	d27	*	*	*	*	*	*	*	*	*	0	2	1
Defrost stop limit 2		1-2	d28	*	*	*	*	*	*	*	*	*	0.0 °C	50.0 °C	6.0 °C
Max. defrost time 2		1-2	d29	*	*	*	*	*	*	*	*	*	d24	360 min	45 min
Display delay after defrost		1-2	d40	*	*	*	*	*	*	*	*	*	5 min	240 min	30 min
Fan stop temperature		1-2	d41	*	*	*	*	*	*	*	*	*	-20.0 °C	20.0 °C	0.0 °C

⁽¹⁾ In order to change this parameter the regulation must be stopped via the parameter r12 Main switch = OFF.

Injection control

Table 19: Injection control

Function	Values	R-W	Code	1	2	3	4	5	6	7	8	9	Min. value	Max. value	Fact. value
Max. superheat limit		1-2	n09	*	*	*	*	*	*	*	*	*	n10	20.0 °C	12.0 °C
Min. superheat limit		1-2	n10	*	*	*	*	*	*	*	*	*	2.0 °C	n09	3.0 °C
MOP temperature		1-2	n11	*	*	*	*	*	*	*	*	*	-60.0 °C	15.0 °C	15.0 °C
AKV Period time		1-2 ⁽¹⁾	n13	*	*	*	*	*	*	*	*	*	3 s	6 s	6 s

⁽¹⁾ In order to change this parameter the regulation must be stopped via the parameter r12 Main switch = OFF.

Fan control

Table 20: Fan control

Function	Values	R-W	Code	1	2	3	4	5	6	7	8	9	Min. value	Max. value	Fact. value
Fan stop high S5 temp.		1-2	F04	*	*	*	*	*	*	*	*	*	-60.0 °C	50.0 °C	50.0 °C
Fan pulsing mode	0=No pulsing, 1=Pulsing cut-out, 2=Pulsing cut-out night	1-2	F05	*	*	*	*	*	*	*	*	*	0	2	0
Fan period time		1-2	F06	*	*	*	*	*	*	*	*	*	1 min	30 min	5 min
Fan ON cycle		1-2	F07	*	*	*	*	*	*	*	*	*	0 %	100 %	100%

Defrost schedule

Table 21: Defrost schedule

Function	Values	R-W	Code	1	2	3	4	5	6	7	8	9	Min. value	Max. value	Fact. value
Defrost schedule	0=No, 1=Yes	1-2	t00	*	*	*	*	*	*	*	*	*	0	1	0
Def. start 1 - Hours		1-2	t01	*	*	*	*	*	*	*	*	*	0 h	23 h	0 h
Def. start 1 - Minutes		1-2	t11	*	*	*	*	*	*	*	*	*	0 min	59 min	0 min
Def. start 2 - Hours		1-2	t02	*	*	*	*	*	*	*	*	*	0 h	23 h	0 h
Def. start 2 - Minutes		1-2	t12	*	*	*	*	*	*	*	*	*	0 min	59 min	0 min
Def. start 3 - Hours		1-2	t03	*	*	*	*	*	*	*	*	*	0 h	23 h	0 h
Def. start 3 - Minutes		1-2	t13	*	*	*	*	*	*	*	*	*	0 min	59 min	0 min
Def. start 4 - Hours		1-2	t04	*	*	*	*	*	*	*	*	*	0 h	23 h	0 h
Def. start 4 - Minutes		1-2	t14	*	*	*	*	*	*	*	*	*	0 min	59 min	0 min
Def. start 5 - Hours		1-2	t05	*	*	*	*	*	*	*	*	*	0 h	23 h	0 h
Def. start 5 - Minutes		1-2	t15	*	*	*	*	*	*	*	*	*	0 min	59 min	0 min
Def. start 6 - Hours		1-2	t06	*	*	*	*	*	*	*	*	*	0 h	23 h	0 h
Def. start 6 - Minutes		1-2	t16	*	*	*	*	*	*	*	*	*	0 min	59 min	0 min
Time hours		0-1	t07	*	*	*	*	*	*	*	*	*	0 h	23 h	0 h
Time minutes		0-1	t08	*	*	*	*	*	*	*	*	*	0 min	59 min	0 min
Time date		0-1	t45	*	*	*	*	*	*	*	*	*	1	31	1
Time month		0-1	t46	*	*	*	*	*	*	*	*	*	1	12	1
Time year		0-1	t47	*	*	*	*	*	*	*	*	*	0	100	0
Monday - Follow schedule	0=No, 1=Yes	1-2	t51	*	*	*	*	*	*	*	*	*	0	1	1
Tuesday - Follow schedule	0=No, 1=Yes	1-2	t52	*	*	*	*	*	*	*	*	*	0	1	1
Wednesday - Follow schedule	0=No, 1=Yes	1-2	t53	*	*	*	*	*	*	*	*	*	0	1	1
Thursday - Follow schedule	0=No, 1=Yes	1-2	t54	*	*	*	*	*	*	*	*	*	0	1	1
Friday - Follow schedule	0=No, 1=Yes	1-2	t55	*	*	*	*	*	*	*	*	*	0	1	1
Saturday - Follow schedule	0=No, 1=Yes	1-2	t56	*	*	*	*	*	*	*	*	*	0	1	1
Sunday - Follow schedule	0=No, 1=Yes	1-2	t57	*	*	*	*	*	*	*	*	*	0	1	1

Humidity control

Table 22: Humidity control

Function	Values	R-W	Code	1	2	3	4	5	6	7	8	9	Min. value	Max. value	Fact. value
Humidity cut-in		0-2	h23								*		0 RH%	100 RH%	70RH%
Humidity differential		1-2	h24								*		1 RH%	30 RH%	5RH%
Humidity high alarm limit		1-2	h25								*		0 RH%	100 RH%	100RH%
Humidity low alarm limit		1-2	h26								*		0 RH%	100 RH%	0RH%
Humidity alarm delay		1-2	h27								*		0 min	240 min	60 min
Humidity ctrl. at defrost	0=No, 1=Yes	1-2	h28								*		0	1	0
Humidity sensor - Min signal		1-2 ⁽¹⁾	h29								*		0 RH%	h30	0RH%
Humidity sensor - Max signal		1-2 ⁽¹⁾	h30								*		h29	100 RH%	100RH%
Humidity control	0=None, 1=Humidifier, 2=Dehumidifier	1-3 ⁽¹⁾	h31								*		0	2	0
Humidity max. temp.		1-2	h32								*		h33	70.0 °C	70.0 °C
Humidity min. temp.		1-2	h33								*		-5.0 °C	h32	2.0 °C

⁽¹⁾ In order to change this parameter the regulation must be stopped via the parameter r12 Main switch = OFF.

Miscellaneous

Table 23: Miscellaneous

Function	Values	R-W	Code	1	2	3	4	5	6	7	8	9	Min. value	Max. value	Fact. value
Delay of outputs at power-up		1-2	o01	*	*	*	*	*	*	*	*	*	0 s	600 s	5 s
DI1 Configuration	0=None, 1=DI status, 2=Door function, 3=Door alarm, 4=Defrost start, 5=Main switch, 6=Night setback, 7=Thermostat band, 8=Alarm at closed, 9=Alarm at open, 10=Case cleaning, 11=Forced cooling, 12=Open blinds, 13=Coordinated defrost, 14=Forced closing, 15=Shutdown, 16=Light control, 20=Leak detection, 21=Adaptive liquid control, 22=Valve driver, 23=Fan alarm, 29=Door fan stop, 30=Oil recovery	1-2 ⁽¹⁾	o02	*	*	*	*	*	*			*	0	30	0
Network address		1-3 ⁽¹⁾	o03	*	*	*	*	*	*	*	*	*	0	240	0
Service pin	0=OFF, 1=ON	1-2	o04	*	*	*	*	*	*	*	*	*	0	1	0
Access code 3		3-3	o05	*	*	*	*	*	*	*	*	*	0	999	0
Temperature sensor type	0=Pt 1000, 1=PTC 1000, 2=NTC 5k, 3=NTC 10k, 4=User-defined	1-3 ⁽¹⁾	o06	*	*	*	*	*	*	*	*	*	0	4	0
Max. hold time		1-2	o16	*	*	*	*	*	*	*	*	*	0 min	360 min	20 min
Display air S4%		1-2	o17	*	*	*	*	*	*	*	*	*	0 %	100 %	100%
Pe Min range		1-3 ⁽¹⁾	o20	*	*	*	*	*	*	*	*	*	-1.0 Bar	5.0 Bar	-1.0Bar
Pe Max range		1-3 ⁽¹⁾	o21	*	*	*	*	*	*	*	*	*	6.0 Bar	200.0 Bar	12.0 Bar
AO1 Min. voltage		1-3 ⁽¹⁾	o27	*	*	*	*	*	*	*	*	*	0.0 V	o28	0.0V
AO1 Max. voltage		1-3 ⁽¹⁾	o28	*	*	*	*	*	*	*	*	*	o27	10.0 V	10.0 V

AK-CC55 Single Coil and AK-CC55 Single Coil UI

Function	Values	R-W	Code	1	2	3	4	5	6	7	8	9	Min. value	Max. value	Fact. value
Refrigerant	0=Not selected, 6=R13, 7=R13b1, 2=R22, 8=R23, 14=R32, 11=R114, 3=R134a, 12=R142b, 24=R170, 15=R227, 25=R290, 16=R401A, 18=R402A, 19=R404A, 21=R407A, 22=R407B, 20=R407C, 37=R407F, 49=R407H, 23=R410A, 32=R413A, 30=R417A, 31=R422A, 33=R422D, 34=R427A, 35=R438A, 40=R448A, 41=R449A, 48=R449B, 43=R450A, 44=R452B, 45=R454B, 9=R500, 4=R502, 10=R503, 17=R507, 36=R513A, 26=R600, 27=R600a, 5=R717, 28=R744, 46=R1233zdE, 38=R1234ze, 39=R1234yf, 47=R1234zeZ, 29=R1270, 42=R452A, 1=User defined display, 13=User defined	1-3 ⁽¹⁾	o30	*	*	*	*	*	*	*	*	*	0	49	0
DI2 Configuration	0=None, 1=DI status, 2=Door function, 3=Door alarm, 4=Defrost start, 5=Main switch, 6=Night setback, 7=Thermostat band, 8=Alarm at closed, 9=Alarm at open, 10=Case cleaning, 11=Forced cooling, 12=Open blinds, 13=Coordinated defrost, 14=Forced closing, 15=Shutdown, 16=Light control, 20=Leak detection, 21=Adaptive liquid control, 22=Valve driver, 23=Fan alarm, 29=Door fan stop, 30=Oil recovery	1-2 ⁽¹⁾	o37	*	*	*	*	*	*	*	*	*	0	30	0
Light control mode	1=Day and night, 2=Network, 3=Door switch, 4=Network (Fallback), 5=Digital input	1-2	o38	*	*		*	*	*	*	*	*	1	5	1
MC Light signal	0=OFF, 1=ON	1-2	o39	*	*		*	*	*	*	*	*	0	1	0
Rail heat ON cycle day		1-2	o41	*	*	*	*	*	*	*	*	*	0 %	100 %	100%
Rail heat ON cycle night		1-2	o42	*	*	*	*	*	*	*	*	*	0 %	100 %	100%
Rail heat period time		1-2	o43		*	*	*		*			*	6 min	60 min	6 min
Case cleaning mode	0=OFF, 1=Fans run, 2=Cleaning	0-1	o46	*	*	*	*	*	*	*	*	*	0	2	0
Application mode	1=1. Comp/Alarm/Light, 2=2. Comp/Rail/Light, 3=3. Comp/Alarm/Rail, 4=4. Alarm/Rail/Light, 5=5. Hot gas remote, 6=6. Dual with 1 evap., 7=7. Dual with 2 evap., 8=8. Cold room, 9=9. Custom	1-3 ⁽¹⁾	o61	*	*	*	*	*	*	*	*	*	1	9	1
Access code 2		2-2	o64	*	*	*	*	*	*	*	*	*	0	999	0
Make new factory	0=OFF, 1=ON	3-3 ⁽¹⁾	o67	*	*	*	*	*	*	*	*	*	0	1	0

AK-CC55 Single Coil and AK-CC55 Single Coil UI

Function	Values	R-W	Code	1	2	3	4	5	6	7	8	9	Min. value	Max. value	Fact. value
D13 Configuration	0=None, 1=DI status, 2=Door function, 3=Door alarm, 4=Defrost start, 5=Main switch, 6=Night setback, 7=Thermostat, band, 8=Alarm at closed, 9=Alarm at open, 10=Case cleaning, 11=Forced cooling, 12=Open blinds, 13=Coordinated defrost, 14=Forced closing, 15=Shutdown, 16=Light control, 20=Leak detection, 21=Adaptive liquid control, 22=Valve driver, 23=Fan alarm, 29=Door fan stop, 30=Oil recovery	1-2 ⁽¹⁾	o84	*	*	*	*	*	*	*	*	*	0	30	0
Rail heat control mode	0=ON, 1=Day/Night timer, 2=Dewpoint ctrl.	1-2	o85	*	*	*	*	*	*	*	*	*	0	2	0
Dewpoint min. limit		1-2	o86	*	*	*	*	*	*	*	*	*	-10.0 °C	o87	8.0 °C
Dewpoint max. limit		1-2	o87	*	*	*	*	*	*	*	*	*	o86	50.0 °C	17.0 °C
Rail heat min. ON cycle		1-2	o88	*	*	*	*	*	*	*	*	*	0 %	100 %	30%
Door restart inj. delay		1-2	o89	*	*	*	*	*	*	*	*	*	0 min	240 min	30 min
Fan at forced closing	0=OFF, 1=ON, 2=OFF and suppress defrost, 3=ON and suppress defrost	1-2	o90	*	*	*	*	*	*	*	*	*	0	3	1
Display readout	1=Display air, 2=S6 Product temp.	1-2	o97	*	*	*	*	*			*	*	1	2	1
Light at Main switch OFF	0=OFF, 1=Normal ctrl.	1-2	o98	*	*		*	*	*	*	*	*	0	1	0

⁽¹⁾ In order to change this parameter the regulation must be stopped via the parameter r12 Main switch = OFF.

Control

Table 24: Control

Function	Values	R-W	Code	1	2	3	4	5	6	7	8	9	Min. value	Max. value	Fact. value
Alarm relay priority	0=Not used, 1=High Priority, 2=Medium priority, 3=All	1-2	P41	*		*	*		*	*	*	*	0	3	2
Blinds max. open time		1-2	P60									*	0 min	60 min	5 min
Fan stop at blinds closing		1-2	P65	*	*		*	*	*	*	*	*	0 s	300 s	0s
Rail heat PWM - Period time		1-2	P82	*	*	*	*	*	*	*	*	*	4 s	60 s	10 s
Refrigerant factor K1		1-3 ⁽¹⁾	P83	*	*	*	*	*	*	*	*	*	-999	999	300
Refrigerant factor K2		1-3 ⁽¹⁾	P84	*	*	*	*	*	*	*	*	*	-999	999	300
Refrigerant factor K3		1-3 ⁽¹⁾	P85	*	*	*	*	*	*	*	*	*	-999	999	300
Max. superheat liquid ctrl. A		1-2	P86	*	*	*	*	*	*	*	*	*	P87	20.0 °C	3.0 °C
Min. superheat liquid ctrl A		1-2	P87	*	*	*	*	*	*	*	*	*	0.0 °C	P86	1.0 °C
Access code 1		1-1	P88	*	*	*	*	*	*	*	*	*	0	999	0
Display keyboard lock	0=None, 1=Local, 2=Network	1-2	P89	*	*	*	*	*	*	*	*	*	0	2	0
LLSV closing delay		1-2	P92	*	*	*	*	*	*		*	*	0 s	300 s	5 s

⁽¹⁾ In order to change this parameter the regulation must be stopped via the parameter r12 Main switch = OFF.

DO config and manual

Table 25: DO config and manual

Function	Values	R-W	Code	1	2	3	4	5	6	7	8	9	Min. value	Max. value	Fact. value
DO2 Configuration	0=None, 1=Fans, 2=Fan ECO, 3=Defrost, 4=Rail heat, 5=Alarm, 6=Light, 7=Blinds, 8=Compressor/LLSV, 9=Compressor 2, 10=Air heater	1-3 ⁽¹⁾	q02									*	0	10	5
DO3 Configuration	0=None, 1=Fans, 2=Fan ECO, 3=Defrost, 4=Rail heat, 5=Alarm, 6=Light, 7=Blinds, 8=Compressor/LLSV, 9=Compressor 2, 10=Air heater	1-3 ⁽¹⁾	q03									*	0	10	8
DO4 Configuration	0=None, 1=Fans, 2=Fan ECO, 3=Defrost, 4=Rail heat, 5=Alarm, 6=Light, 7=Blinds, 8=Compressor/LLSV, 9=Compressor 2, 10=Air heater	1-3 ⁽¹⁾	q04									*	0	10	9
DO5 Configuration	0=None, 1=Fans, 2=Fan ECO, 3=Defrost, 4=Rail heat, 5=Alarm, 6=Light, 7=Blinds, 8=Compressor/LLSV, 9=Compressor 2, 10=Air heater	1-3 ⁽¹⁾	q05									*	0	10	3
DO6 Configuration	0=None, 1=Fans, 2=Fan ECO, 3=Defrost, 4=Rail heat, 5=Alarm, 6=Light, 7=Blinds, 8=Compressor/LLSV, 9=Compressor 2, 10=Air heater	1-3 ⁽¹⁾	q06									*	0	10	1
AO1 Configuration	0=None, 1=Rail heat PWM, 2=Valve driver	1-3 ⁽¹⁾	q09	*	*	*	*	*	*	*	*	*	0	2	0
EEV override A		1-2 ⁽²⁾	q11	*	*	*	*	*	*	*	*	*	0 %	100 %	0%
Compressor 1 - override	0=MAN OFF, 1=MAN ON	1-2 ⁽²⁾	q12	*	*	*						*	0	1	0
Fan - override	0=MAN OFF, 1=MAN ON	1-2 ⁽²⁾	q13	*	*	*	*	*	*	*	*	*	0	1	0
Defrost A - override	0=MAN OFF, 1=MAN ON	1-2 ⁽²⁾	q14	*	*	*	*		*	*	*	*	0	1	0
Rail heat - override	0=MAN OFF, 1=MAN ON	1-2 ⁽²⁾	q15		*	*	*		*			*	0	1	0
Alarm relay - override	0=MAN OFF, 1=MAN ON	1-2 ⁽²⁾	q16	*		*	*		*	*	*	*	0	1	0
Light - override	0=MAN OFF, 1=MAN ON	1-2 ⁽²⁾	q17	*	*		*	*	*	*	*	*	0	1	0
Suction valve - override	0=MAN OFF, 1=MAN ON	1-2 ⁽²⁾	q18					*					0	1	0
Compressor 2 - override	0=MAN OFF, 1=MAN ON	1-2 ⁽²⁾	q19									*	0	1	0
Hot gas valve - override	0=MAN OFF, 1=MAN ON	1-2 ⁽²⁾	q20					*					0	1	0
Blinds - override	0=MAN OFF, 1=MAN ON	1-2 ⁽²⁾	q21									*	0	1	0
Defrost B - override	0=MAN OFF, 1=MAN ON	1-2 ⁽²⁾	q22							*			0	1	0
Air heater - override	0=MAN OFF, 1=MAN ON	1-2 ⁽²⁾	q23									*	0	1	0
Fan ECO - override	0=MAN OFF, 1=MAN ON	1-2 ⁽²⁾	q24									*	0	1	0
Drain valve - override	0=MAN OFF, 1=MAN ON	1-2 ⁽²⁾	q25					*					0	1	0
Humidifier - override	0=MAN OFF, 1=MAN ON	1-2 ⁽²⁾	q26									*	0	1	0
Rail heat PWM - override		1-2 ⁽²⁾	q27	*	*	*	*	*	*	*	*	*	0 %	100 %	0%
High temperature - Priority	0=Disabled, 3=Low, 2=Medium, 1=High	1-2	q28	*	*	*	*	*	*	*	*	*	0	3	1
Low temperature - Priority	0=Disabled, 3=Low, 2=Medium, 1=High	1-2	q29	*	*	*	*	*	*	*	*	*	0	3	1
Sensor errors - Priority	0=Disabled, 3=Low, 2=Medium, 1=High	1-2	q30	*	*	*	*	*	*	*	*	*	0	3	1
DI alarms - Priority	0=Disabled, 3=Low, 2=Medium, 1=High	1-2	q31	*	*	*	*	*	*	*	*	*	0	3	2
Defrost - Priority	0=Disabled, 3=Low, 2=Medium, 1=High	1-2	q32	*	*	*	*	*	*	*	*	*	0	3	3
Miscellaneous - Priority	0=Disabled, 3=Low, 2=Medium, 1=High	1-2	q33	*	*	*	*	*	*	*	*	*	0	3	2
Injection - Priority	0=Disabled, 3=Low, 2=Medium, 1=High	1-2	q34	*	*	*	*	*	*	*	*	*	0	3	2
Control stopped - Priority	0=Disabled, 3=Low, 2=Medium, 1=High	1-2	q35	*	*	*	*	*	*	*	*	*	0	3	3

AK-CC55 Single Coil and AK-CC55 Single Coil UI

Function	Values	R-W	Code	1	2	3	4	5	6	7	8	9	Min. value	Max. value	Fact. value
Leak detection - Priority	0=Disabled, 3=Low, 2=Medium, 1=High	1-2	q36	*	*	*	*	*	*	*	*	*	0	3	2
Humidity ctrl. - Priority	0=Disabled, 3=Low, 2=Medium, 1=High	1-2	q37								*		0	3	2
Food temp. sensor	1=Thermostat air, 2=Alarm air, 3=S3 Air ON evap., 4=S6 Product temp.	1-2 ⁽¹⁾	q39	*	*	*	*	*	*	*	*	*	1	4	2
LLSV - override	0=MAN OFF, 1=MAN ON	1-2 ⁽²⁾	q45	*	*	*	*	*	*		*	*	0	1	0
Dehumidifier - override	0=MAN OFF, 1=MAN ON	1-2 ⁽²⁾	q46								*		0	1	0

⁽¹⁾ In order to change this parameter the regulation must be stopped via the parameter r12 Main switch = OFF.

⁽²⁾ In order to change this parameter the parameter r12 Main switch must be set in position "SER" allowing manual control of outputs.

Service

Table 26: Service

Function	Values	R-W	Code	1	2	3	4	5	6	7	8	9	Min. value	Max. value	Fact. value
Control state A	0=Normal ctrl., 1=Hold after defrost, 2=Min ON timer, 3=Min OFF timer, 4=Drip off, 10=Main switch OFF, 11=Thermostat cut-out, 12=Frost protection S4, 14=Defrost, 15=Fan delay, 16=Forced closing, 17=Door open, 18=Melt period, 19=Modulating temp. control, 20=Emergency control, 23=Adaptive superheat control, 24=Start injection, 25=Manual control, 26=No refrigerant selected, 29=Case cleaning, 30=Forced cooling, 31=Door open, 32=Power-up delay, 33=Air heating, 45=Shut down controller, 48=Adaptive liquid control, 51=Oil recovery	0-X	u00	*	*	*	*	*	*	*	*	*	0	51	0
S5 Evaporator A		0-X	u09	*	*	*	*	*	*	*	*	*	-200.0 °C	200.0 °C	0.0 °C
DI1 Status	0=OFF, 1=ON	0-X	u10	*	*	*	*	*	*			*	0	1	0
Defrost time A		0-X	u11	*	*	*	*	*	*	*	*	*	0 min	900 min	0 min
S3 Air ON evap. A		0-X	u12	*	*	*	*	*	*	*	*	*	-200.0 °C	200.0 °C	0.0 °C
Night condition	0=OFF, 1=ON	0-X	u13	*	*	*	*	*	*	*	*	*	0	1	0
S4 Air OFF evap. A		0-X	u16	*	*	*	*	*	*	*	*	*	-200.0 °C	200.0 °C	0.0 °C
Thermostat air temp. A		0-X	u17	*	*	*	*	*	*	*	*	*	-200.0 °C	200.0 °C	0.0 °C
Thermostat run time A		0-X	u18	*	*	*	*	*	*	*	*	*	0 min	999 min	0 min
S2 Gas outlet A		0-X	u20	*	*	*	*	*	*	*	*	*	-200.0 °C	200.0 °C	0.0 °C
Superheat A		0-X	u21	*	*	*	*	*	*	*	*	*	-200.0 °C	200.0 °C	0.0 °C
Superheat reference A		0-X	u22	*	*	*	*	*	*	*	*	*	-200.0 °C	200.0 °C	0.0 °C
EEV opening A		0-X	u23	*	*	*	*	*	*	*	*	*	0 %	100 %	0 %
Pe Evap. pressure		0-X	u25	*	*	*	*	*	*	*	*	*	-1.0 Bar	200.0 Bar	0.0 Bar
Te Evap. temp.		0-X	u26	*	*	*	*	*	*	*	*	*	-200.0 °C	200.0 °C	0.0 °C
S6 product temp.		0-X	u36	*	*	*	*	*			*	*	-200.0 °C	200.0 °C	0.0 °C
DI2 Status	0=OFF, 1=ON	0-X	u37	*	*	*	*	*	*	*	*	*	0	1	0
Display readout 1		0-X	u56	*	*	*	*	*	*	*	*	*	-200.0 °C	200.0 °C	0.0 °C
Alarm air temp. A		0-X	u57	*	*	*	*	*	*	*	*	*	-200.0 °C	200.0 °C	0.0 °C
Compressor 1	0=OFF, 1=ON	0-X	u58	*	*	*						*	0	1	0
Fan	0=OFF, 1=ON	0-X	u59	*	*	*	*	*	*	*	*	*	0	1	0
Defrost A	0=OFF, 1=ON	0-X	u60	*	*	*	*		*	*	*	*	0	1	0
Rail heat	0=OFF, 1=ON	0-X	u61		*	*	*		*			*	0	1	0
Alarm relay	0=OFF, 1=ON	0-X	u62	*		*	*		*	*	*	*	0	1	0
Light	0=OFF, 1=ON	0-X	u63	*	*		*	*	*	*	*	*	0	1	0
Suction valve	0=OFF, 1=ON	0-X	u64					*					0	1	0
Compressor 2	0=OFF, 1=ON	0-X	u67									*	0	1	0

AK-CC55 Single Coil and AK-CC55 Single Coil UI

Function	Values	R-W	Code	1	2	3	4	5	6	7	8	9	Min. value	Max. value	Fact. value
S5 Evaporator B		0-X	u75	*	*	*	*	*	*	*	*	*	-200.0 °C	200.0 °C	0.0 °C
S3 Air ON evap. B		0-X	u76						*	*			-200.0 °C	200.0 °C	0.0 °C
Hot gas valve	0=OFF, 1=ON	0-X	u80					*					0	1	0
Blinds	0=OFF, 1=ON	0-X	u82									*	0	1	0
Defrost B	0=OFF, 1=ON	0-X	u83							*			0	1	0
Air heater	0=OFF, 1=ON	0-X	u84									*	0	1	0
Rail heat power		0-X	u85	*	*	*	*	*	*	*	*	*	0 %	100 %	0%
Thermostat band	1=Band 1, 2=Band 2	0-X	u86	*	*	*	*	*	*	*	*	*	1	2	1
DI3 Status	0=OFF, 1=ON	0-X	u87	*	*	*	*	*	*	*	*	*	0	1	0
Thermostat cut-in temp.		0-X	u90	*	*	*	*	*	*	*	*	*	-200.0 °C	200.0 °C	4.0 °C
Thermostat cut-out temp.		0-X	u91	*	*	*	*	*	*	*	*	*	-200.0 °C	200.0 °C	2.0 °C
Adaptive defrost state	0=OFF, 1=Error, 2=Tuning, 3=OK, 4=Little ice, 5=Medium ice, 6=Heavy ice	0-X	U01	*	*	*	*	*	*	*	*	*	0	6	0
Accumulated defrosts		0-X	U10	*	*	*	*	*	*	*	*	*	0	32767	0
Accumulated skipped defrosts		0-X	U11	*	*	*	*	*	*	*	*	*	0	32767	0
Alarm air temp. B		0-X	U34						*	*			-200.0 °C	200.0 °C	0.0 °C
Display readout 2		0-X	U35	*	*	*	*	*	*	*		*	-200.0 °C	200.0 °C	0.0 °C
Fan ECO	0=OFF, 1=ON	0-X	U37									*	0	1	0
Network status		0-X	U45	*	*	*	*	*	*	*	*	*	0 %	100 %	0%
Drain valve	0=OFF, 1=ON	0-X	U55					*					0	1	0
Humidity sensor		0-X	U57								*		0 %	100 %	0%
Humidifier	0=OFF, 1=ON	0-X	U58								*		0	1	0
Rail heat PWM		0-X	U59	*	*	*	*	*	*	*	*	*	0 %	100 %	0%
Food temperature A		0-X	U72	*	*	*	*	*	*	*	*	*	-200.0 °C	200.0 °C	0.0 °C
Defrost sensor temperature A		0-X	U73	*	*	*	*	*	*	*	*	*	-200.0 °C	200.0 °C	0.0 °C
Liquid line solenoid	0=OFF, 1=ON	0-X	U95	*	*	*	*	*	*		*	*	0	1	0
Dehumidifier	0=OFF, 1=ON	0-X	U96								*		0	1	0

Operation via AK-UI55 Bluetooth

Access to parameters via Bluetooth and app

1. App can be downloaded from App Store and Google Play.
 - Name = AK-CC55 Connect
 - Start the app.
2. Click on the display's Bluetooth button for 3 seconds.
 - The Bluetooth light will then flash while display is showing the controller's address.
3. Connect to the controller from the app.

Figure 55: AK-UI55 Bluetooth

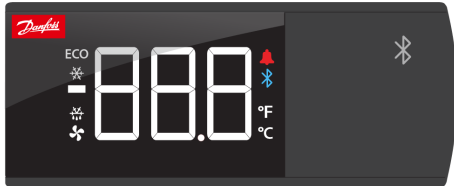

Display info:

- Loc
- The operation is locked and cannot be operated via Bluetooth.
- Unlock from the system manager.

Figure 56: Connect to controller

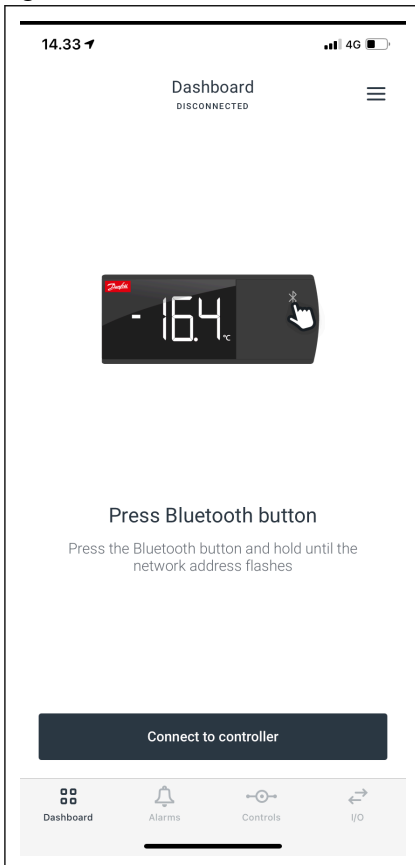

Figure 57: Controller dashboard

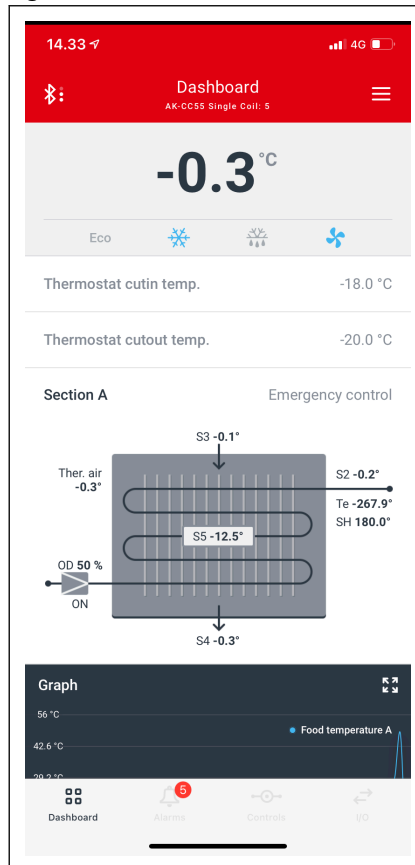
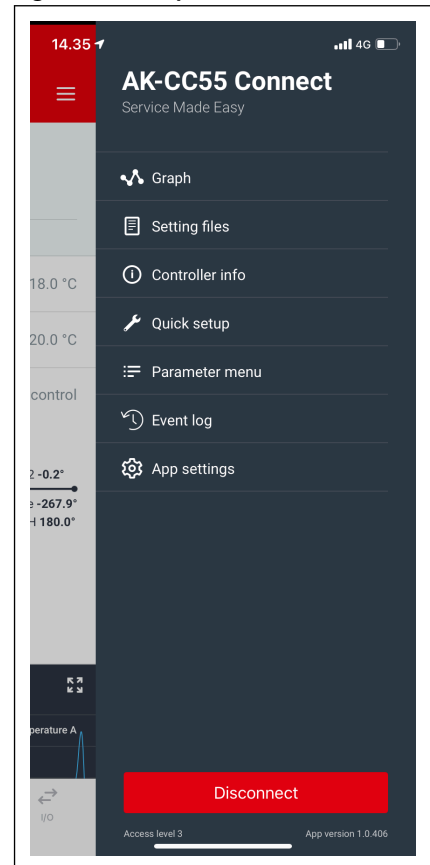

Figure 58: Set-up menu



The functions are described on [Page 54](#) – [Page 69](#).

AK-CC55 connect menu (SW ver. 1.7x)
Start / Stop
Table 27: Start/Stop

Function	Description	Values	Code	Short name
Main switch	Start / stop of refrigeration. With this setting refrigeration can be started, stopped or a manual override of the outputs can be allowed. (For manual control the value is set at -1). Then the outputs can be force controlled. Start / stop of refrigeration can also be accomplished with the external switch function connected to a DI input. Stopped control will give a "Main switch OFF" alarm.	-1=Manual, 0=Stop, 1=Start	r12	r12 Main switch
Delay of outputs at power-up	Delay of output signal after start-up After start-up or a power failure the controller's functions can be delayed so that overloading of the electricity supply network is avoided. Here you can set the time delay.		o01	o01 DelayOfOutp.

Configuration
Table 28: Configuration

Function	Description	Values	Code	Short name
Main switch	Start / stop of refrigeration. With this setting refrigeration can be started, stopped or a manual override of the outputs can be allowed. (For manual control the value is set at -1). Then the outputs can be force controlled. Start / stop of refrigeration can also be accomplished with the external switch function connected to a DI input. Stopped control will give a "Main switch OFF" alarm.	-1=Manual, 0=Stop, 1=Start	r12	r12 Main switch
Application mode	Selection of application The controller covers several applications for control of a refrigerated case. Here you set which of the possible applications is required. This menu can only be set when regulation is stopped, i.e. "r12 Main Switch" is set to 0.	1=1. Comp/Alarm/Light, 2=2. Comp/Rail/Light, 3=3. Comp/Alarm/Rail, 4=4. Alarm/Rail/Light, 5=5. Hot gas remote, 6=6. Dual with 1 evap., 7=7. Dual with 2 evap., 8=8. Cold room, 9=9. Custom	o61	o61 Appl. mode
DO2 Configuration	Select the function of the digital output	0=None, 1=Fans, 2=Fan ECO, 3=Defrost, 4=Rail heat, 5=Alarm, 6=Light, 7=Blinds, 8=Compressor/LLSV, 9=Compressor 2, 10=Air heater	q02	q02 DO2 Config.
DO3 Configuration	Select the function of the digital output	0=None, 1=Fans, 2=Fan ECO, 3=Defrost, 4=Rail heat, 5=Alarm, 6=Light, 7=Blinds, 8=Compressor/LLSV, 9=Compressor 2, 10=Air heater	q03	q03 DO3 Config.
DO4 Configuration	Select the function of the digital output	0=None, 1=Fans, 2=Fan ECO, 3=Defrost, 4=Rail heat, 5=Alarm, 6=Light, 7=Blinds, 8=Compressor/LLSV, 9=Compressor 2, 10=Air heater	q04	q04 DO4 Config.
DO5 Configuration	Select the function of the digital output	0=None, 1=Fans, 2=Fan ECO, 3=Defrost, 4=Rail heat, 5=Alarm, 6=Light, 7=Blinds, 8=Compressor/LLSV, 9=Compressor 2, 10=Air heater	q05	q05 DO5 Config.
DO6 Configuration	Select the function of the digital output	0=None, 1=Fans, 2=Fan ECO, 3=Defrost, 4=Rail heat, 5=Alarm, 6=Light, 7=Blinds, 8=Compressor/LLSV, 9=Compressor 2, 10=Air heater	q06	q06 DO6 Config.
AO1 Configuration	Select the function of the analogue output	0=None, 1=Rail heat PWM, 2=Valve driver	q09	q09 AO1 Config.
AO1 Min. voltage	Minimum voltage signal of the analogue output		o27	o27 AO1 Min volt
AO1 Max. voltage	Maximum voltage signal of the analogue output		o28	o28 AO1 Max volt
DI1 Configuration	Select the function of the digital input	0=None, 1=DI status, 2=Door function, 3=Door alarm, 4=Defrost start, 5=Main switch, 6=Night setback, 7=Thermostat band, 8=Alarm at closed, 9=Alarm at open, 10=Case cleaning, 11=Forced cooling, 12=Open blinds, 14=Forced closing, 15=Shutdown, 16=Light control, 20=Leak detection, 21=Adaptive liquid control, 22=Valve driver, 23=Fan alarm, 29=Door fan stop, 30=Oil recovery	o02	o02 DI1 Config.
DI2 Configuration	Select the function of the digital input	0=None, 1=DI status, 2=Door function, 3=Door alarm, 4=Defrost start, 5=Main switch, 6=Night setback, 7=Thermostat band, 8=Alarm at closed, 9=Alarm at open, 10=Case cleaning, 11=Forced cooling, 12=Open blinds, 13=Coordinated defrost, 14=Forced closing, 15=Shutdown, 16=Light control, 20=Leak detection, 21=Adaptive liquid control, 22=Valve driver, 23=Fan alarm, 29=Door fan stop, 30=Oil recovery	o37	o37 DI2 Config.

AK-CC55 Single Coil and AK-CC55 Single Coil UI

Function	Description	Values	Code	Short name
Dl3 Configuration	Select the function of the digital input	0=None, 1=DI status, 2=Door function, 3=Door alarm, 4=Defrost start, 5=Main switch, 6=Night setback, 7=Thermostat band, 8=Alarm at closed, 9=Alarm at open, 10=Case cleaning, 11=Forced cooling, 12=Open blinds, 13=Coordinated defrost, 14=Forced closing, 15=Shutdown, 16=Light control, 20=Leak detection, 21=Adaptive liquid control, 29=Door fan stop, 30=Oil recovery	o84	o84 Dl3 Config
Refrigerant	Select the type of refrigerant. If the required refrigerant is not part of the list, the user defined option can be used. Please contact Danfoss for detailed information ⚠ WARNING: Wrong selection of refrigerant may cause damage to the system.	0=Not selected, 6=R13, 7=R13b1, 2=R22, 8=R23, 14=R32, 11=R114, 3=R134a, 12=R142b, 24=R170, 15=R227, 25=R290, 16=R401A, 18=R402A, 19=R404A, 21=R407A, 22=R407B, 20=R407C, 37=R407F, 49=R407H, 23=R410A, 32=R413A, 30=R417A, 31=R422A, 33=R422D, 34=R427A, 35=R438A, 40=R448A, 41=R449A, 48=R449B, 43=R450A, 44=R452B, 45=R454B, 9=R500, 4=R502, 10=R503, 17=R507, 36=R513A, 26=R600, 27=R600a, 5=R717, 28=R744, 46=R1233zdE, 38=R1234ze, 39=R1234yf, 47=R1234zeZ, 29=R1270, 42=R452A, 1=User defined display, 13=User defined	o30	o30 Refrigerant
Refrigerant factor K1	Refrigerant factor for a custom refrigerant - please contact Danfoss for detailed information		P83	P83 RfgFac.K1
Refrigerant factor K2	Refrigerant factor for a custom refrigerant - please contact Danfoss for detailed information		P84	P84 RfgFac.K2
Refrigerant factor K3	Refrigerant factor for a custom refrigerant - please contact Danfoss for detailed information		P85	P85 RfgFac.K3
Refrigerant factor A1	Refrigerant factor for a custom refrigerant - please contact Danfoss for detailed information		x65	--- Rfg.Fac.A1
Refrigerant factor A2	Refrigerant factor for a custom refrigerant - please contact Danfoss for detailed information		x66	--- Rfg.Fac.A2
Refrigerant factor A3	Refrigerant factor for a custom refrigerant - please contact Danfoss for detailed information		x67	--- Rfg.Fac.A3
Pe Min range	Minimum measuring range for sensor		o20	o20 MinTransPres
Pe Max range	Maximum measuring range for sensor		o21	o21 MaxTransPres
Temperature sensor type	Sensor type for S3, S4 and S5. Normally a Pt 1000 sensor with great signal accuracy is used. But you can also use a sensor with another signal accuracy. That could e.g. be a PTC sensor (1000 ohm at 25 °C). All the mounted sensors S3-S5 must be of the same type.	0=Pt 1000, 1=PTC 1000, 2=NTC 5k, 3=NTC 10k, 4=User-defined	o06	o06 SensorConfig
Sensor point 1 - Temp.	The temperature value for the user-defined temperature sensor in the reference point		X20	--- SP1 Temp.
Sensor point 1 - kohm	The resistance value in kohm for the user-defined temperature sensor in the reference point		X21	--- SP1 kohm
Sensor point 1 - ohm	The resistance value in ohm for the user-defined temperature sensor in the reference point		X22	--- SP1 Ohm
Sensor point 2 - Temp.	The temperature value for the user-defined temperature sensor in the reference point		X23	--- SP2 Temp.
Sensor point 2 - kohm	The resistance value in kohm for the user-defined temperature sensor in the reference point		X24	--- SP2 kohm
Sensor point 2 - ohm	The resistance value in ohm for the user-defined temperature sensor in the reference point		X25	--- SP2 Ohm
Sensor point 3 - Temp.	The temperature value for the user-defined temperature sensor in the reference point		X26	--- SP3 Temp.
Sensor point 3 - kohm	The resistance value in kohm for the user-defined temperature sensor in the reference point		X27	--- SP3 kohm
Sensor point 3 - ohm	The resistance value in ohm for the user-defined temperature sensor in the reference point		X28	--- SP3 Ohm
Food type	When changing the food type the controller will automatically adapt temperature setpoints and alarm limits according to the selected food type. Please be aware that the setting will revert to "None" after having been changed.	0=None, 1=Vegetables, 2=Dairy, 3=Meat and fish, 4=Frozen food, 5=Ice cream	r89	r89 Food type
Food temp. sensor	Select the temperature to be used for the food temperature representation	1=Thermostat air, 2=Alarm air, 3=S3 Air ON evap., 4=S6 Product temp.	q39	q39 Food sensor
Defrost method	Select method of defrost	0=None, 1=Electrical, 2=Hot gas, 4=Air/Offcycle	d01	d01 Def. method
Defrost stop method	Here you define whether a defrost cycle is to be stopped by time or by a temperature sensor	0=Time, 1=S5 sensor, 2=S4 sensor, 3=S5A and S5B	d10	d10 DefStopSens.

AK-CC55 Single Coil and AK-CC55 Single Coil UI

Function	Description	Values	Code	Short name
Defrost stop limit A	When the selected defrost stop sensor reaches the set limit, the defrost cycle is terminated		d02	d02 Def.StopTemp
Network address	Network address of the controller		o03	o03 Unit addr.
Service pin	If the controller is built into a LonWorks network with data communication, it must have an address, and the system manager must know this address. The address is sent to the system manager when the menu is set in pos. ON. ! IMPORTANT: Before you set o04, you MUST set the application mode of the controller (The function is not used when the data communication is MODBUS)	0=OFF, 1=ON	o04	o04 Service pin

Thermostat control

Table 29: Thermostat control

Function	Description	Values	Code	Short name
Control state A	Readout of the actual control state of the controller	0=Normal ctrl., 1=Hold after defrost, 2=Min ON timer, 3=Min OFF timer, 4=Drip off, 10=Main switch OFF, 11=Thermostat cut-out, 12=Frost protection S4, 14=Defrost, 15=Fan delay, 16=Forced closing, 17=Door open, 18=Melt period, 19=Modulating temp. control, 20=Emergency control, 23=Adaptive superheat control, 24=Start injection, 25=Manual control, 26=No refrigerant selected, 29=Case cleaning, 30=Forced cooling, 31=Door open, 32=Power-up delay, 33=Air heating, 45=Shut down controller, 48=Adaptive liquid control, 51=Oil recovery	u00	u00 Ctrl. state
Thermostat air temp. A	Thermostat temperature		u17	u17 Ther. air
Food temperature A	Readout of food temperature		U72	U72 Food temp.
S3 Air ON evap. A	Actual sensor value		u12	u12 S3 air temp.
S3 Air ON evap. B	Actual sensor value		u76	u76 S3 airtemp B
S4 Air OFF evap. A	Actual sensor value		u16	u16 S4 air temp.
Night condition	Status of the day/night operation (night operation: on/off)	0=OFF, 1=ON	u13	u13 Night Cond.
Thermostat cut-in temp.	Readout of the actual cut-in value for the thermostat		u90	u90 Cutin temp.
Thermostat cut-out temp.	Readout of the actual cut-out value for the thermostat		u91	u91 Cutout temp.
Thermostat run time A	Read the ongoing cut-in time for the thermostat or the duration of the last completed cut-in		u18	u18 Ther runtime
Thermostat band	Readout of which thermostat is used for regulation: 1=Thermostat band, 12=Thermostat band 2	1=Band 1, 2=Band 2	u86	u86 Ther. band
Air heater	Actual status of output function	0=OFF, 1=ON	u84	u84 Heat relay
Thermostat mode	Here it is defined how the thermostat is to be operated. Either as an ordinary ON/OFF thermostat or as a modulating thermostat. When operation is "modulating" the valve will limit the flow of refrigerant so that the temperature variation will be less than for the ON/OFF thermostat. The thermostat differential (r01) must not be set lower than 2K for "modulating". In a decentralised plant you must select the ON/OFF thermostat setting.	1=ON/OFF, 2=Modulating	r14	r14 Therm. mode
Cut-out 1	Setpoint. The thermostat's cut-out value when the given thermostat band is in use		r00	r00 Cutout
Cut-out 2	Setpoint. The thermostat's cut-out value when the given thermostat band is in use		r21	r21 Cutout 2
Differential 1	When the temperature is higher than the set cut-out + the set differential, the compressor relay will be cut-in. It will cut-out again when the temperature comes down to the set cut-out limit		r01	r01 Differential
Differential 2	When the temperature is higher than the set cut-out + the set differential, the compressor relay will be cut-in. It will cut-out again when the temperature comes down to the set cut-out limit		r93	r93 Diff Th2

AK-CC55 Single Coil and AK-CC55 Single Coil UI

Function	Description	Values	Code	Short name
Max cut-out limit	Setpoint limitation - The controller's setting range for the thermostat setpoint may be narrowed down, so that too high or too low values are not set accidentally - with resulting damages. To avoid a too high setting of the setpoint, the max. allowable reference value may be lowered		r02	r02 Max cutout
Min cut-out limit	Setpoint limitation - The controller's setting range for the thermostat setpoint may be narrowed down, so that too high or too low values are not set accidentally - with resulting damages. To avoid a too low setting of the setpoint, the min. allowable reference value may be increased		r03	r03 Min cutout
Thermostat sensor S4 %	Selection of thermostat sensor. Here you define the sensor that the thermostat is to use for its control function. S3, S4, or a combination of them. With the setting 0%, only S3 is used. With 100%, only S4.		r15	r15 Ther. S4 %
Thermostat sensor S4 % night	Selection of thermostat sensor S4% during night operation with night blinds. Here you define the sensor that the thermostat is to use for its control function. S3, S4, or a combination of them. With the setting 0%, only S3 is used. With 100%, only S4.		r61	r61 Ther.S4% Ngt
Night offset	Night setback value. The thermostat's reference will be the setpoint plus this value when the controller changes over to night operation.		r13	r13 Night offset
S4 frost protection	Frost protection on S4 air temperature. If the S4 temperature sensor measure a temperature lower than the set limit, refrigeration will be stopped in order to protect products from ice formation. Refrigeration will start again when the S4 temperature has risen 2K above the set limit		r98	r98 S4 Min Lim
Air heater neutral zone	Heat function. Set the width of the Neutral Zone for changeover from cooling to heating		r62	r62 Heat NZ
Air heater start delay	Time delay on transition from refrigeration phase to heating phase (there is no time delay on transition from heating phase to refrigeration)		r63	r63 HeatStartDel
Melt interval	Melt function. Only for control of MT cases/rooms (-5 – +10 °C). The function ensures that the evaporator will not be blocked by ice crystals. Here you set how often the function is to stop the refrigeration and hence transform the ice crystals to water.		r16	r16 MeltInterval
Melt period	Melt period. Here you set how long an ongoing melt function is to last		r17	r17 Melt period

Alarm limits and delays

Table 30: Alarm limits and delays

Function	Description	Values	Code	Short name
Alarm status	Actual alarm status	0=OFF, 1=ON	x16	--- Sum alarm
Control state A	Readout of the actual control state of the controller	0=Normal ctrl., 1=Hold after defrost, 2=Min ON timer, 3=Min OFF timer, 4=Drip off, 10=Main switch OFF, 11=Thermostat cut-out, 12=Frost protection S4, 14=Defrost, 15=Fan delay, 16=Forced closing, 17=Door open, 18=Melt period, 19=Modulating temp. control, 20=Emergency control, 23=Adaptive superheat control, 24=Start injection, 25=Manual control, 26=No refrigerant selected, 29=Case cleaning, 30=Forced cooling, 31=Door open, 32=Power-up delay, 33=Air heating, 45=Shut down controller, 48=Adaptive liquid control, 51=Oil recovery	u00	u00 Ctrl. state
Alarm air temp. A	Measured temperature for alarm thermostat		u57	u57 Alarm air
Alarm air temp. B	Measured temperature for alarm thermostat		U34	U34 Alarm air B
High alarm limit	Readout of actual high alarm limit for the temperature monitoring		y10	--- High al. lim
Low alarm limit	Readout of actual low alarm limit for the temperature monitoring		y11	--- Low al. lim
S3 Air ON evap. A	Actual sensor value		u12	u12 S3 air temp.
S3 Air ON evap. B	Actual sensor value		u76	u76 S3 airtemp B
S4 Air OFF evap. A	Actual sensor value		u16	u16 S4 air temp.
S6 product temp.	Actual sensor value		u36	u36 S6 temp.
Reset alarms	Command for resetting all alarms, unless they are still active	0=OFF, 1=ON	x15	--- Reset alarm

AK-CC55 Single Coil and AK-CC55 Single Coil UI

Function	Description	Values	Code	Short name
Alarm sensor S4% A	Signal to the alarm thermostat Here you have to define the ratio between the sensors which the alarm thermostat has to use. S3, S4 or a combination of the two. With setting 0% only S3 is used. With 100% only S4 is used		A36	A36 Alarm S4 %
High alarm limit 1	Upper alarm limit. The limit value is set in absolute value. The limit value will be raised with the night offset during night operation.		A13	A13 HighLim Air
Low alarm limit 1	Lower alarm limit. The limit value is set in absolute value		A14	A14 LowLim Air
High alarm limit 2	Upper alarm limit. The limit value is set in absolute value. The limit value will be raised with the night offset during night operation.		A20	A20 HighLim2 Air
Low alarm limit 2	Lower alarm limit. The limit value is set in absolute value		A21	A21 LowLim2 Air
Alarm delay A	Alarm delay (short alarm delay on air temperature). If the upper or the lower alarm limit values are exceeded, a timer function will commence. The alarm will not become active until the set time delay has been passed. The time delay is set in minutes		A03	A03 Alarm delay
Alarm delay pull down A	Alarm delay at temperature pull down conditions (long alarm delay). This time delay is used during start-up, during defrost and immediately after a defrost. There will be a change-over to the normal time delay when the temperature has dropped below the set upper alarm limit.		A12	A12 Pulldown del
Alarm delay B	Alarm delay (short alarm delay on air temperature). If the upper or the lower alarm limit values are exceeded, a timer function will commence. The alarm will not become active until the set time delay has been passed. The time delay is set in minutes		A53	A53 Al.Del.S3 B
Use product sensor S6	Select whether a separate S6 product sensor must be used for monitoring of the product temperature	0=No, 1=Yes	a01	a01 S6 function
S6 High alarm limit 1	Upper alarm limit for S6 product temperature. The limit is raised with the nightoffset during night operation.		A22	A22 HighLim1 S6
S6 Low alarm limit 1	Lower alarm limit for S6 product temperature		A23	A23 LowLim1 S6
S6 High alarm limit 2	Upper alarm limit for S6 product temperature. The limit is raised with the nightoffset during night operation.		A24	A24 HighLim2 S6
S6 Low alarm limit 2	Lower alarm limit for S6 product temperature		A25	A25 LowLim2 S6
S6 alarm delay	S6 temperature alarm delay. The alarm is activated if one of the relevant alarm limits is exceeded. The time delay is set in minutes. (Alarms will not activate when the setting is set to the maximum value.)		A26	A26 AL.Delay S6
S6 alarm pull down delay	Time delay on S6 (product sensor) at temperature pull down conditions (long alarm delay). This time delay is used for start-up, during defrosting, immediately after a defrost and after an appliance cleaning. A change is carried out to standard time delay when the temperature has reached below the set upper alarm limit.		A52	A52 PullD del.S6
Door open alarm delay	Time delay for door alarm		A04	A04 DoorOpen del
Door restart inj. delay	Start of refrigeration when the door is open. If the door has been left open, refrigeration will be started after the set time.		o89	o89 DoorInjStart
Alarm delay DI 1	Time delay for digital input alarm		A27	A27 Al.Delay DI1
Alarm delay DI 2	Time delay for digital input alarm		A28	A28 Al.Delay DI2

Humidity control

Table 31: Humidity control

Function	Description	Values	Code	Short name
Control state A	Readout of the actual control state of the controller	0=Normal ctrl., 1=Hold after defrost, 2=Min ON timer, 3=Min OFF timer, 4=Drip off, 10=Main switch OFF, 11=Thermostat cut-out, 12=Frost protection S4, 14=Defrost, 15=Fan delay, 16=Forced closing, 17=Door open, 18=Melt period, 19=Modulating temp. control, 20=Emergency control, 23=Adaptive superheat control, 24=Start injection, 25=Manual control, 26=No refrigerant selected, 29=Case cleaning, 30=Forced cooling, 31=Door open, 32=Power-up delay, 33=Air heating, 45=Shut down controller, 48=Adaptive liquid control, 51=Oil recovery	u00	u00 Ctrl. state
Humidity sensor			U57	U57 RH level %
Humidifier	Actual status of output function	0=OFF, 1=ON	U58	U58 Humidifier
Dehumidifier	Actual status of output function	0=OFF, 1=ON	U96	U96 Dehumidifier
Humidity control	Select the type of humidity control	0=None, 1=Humidifier, 2=Dehumidifier	h31	h31 RH function
Humidity cut-in	Setpoint for the humidity control. If the relative humidity goes below the setpoint, the humidifier is started		h23	h23 RH Cutin SP
Humidity differential	Differential for stopping humidifier. Humidification is stopped when the humidity has increased with the set differential above the setpoint		h24	h24 RH Diff.
Humidity high alarm limit	High alarm limit for relative humidity		h25	h25 RH HighLimAI
Humidity low alarm limit	Low alarm limit for relative humidity		h26	h26 RH LowLimAI
Humidity alarm delay	Delay of high and low humidity alarms		h27	h27 RH Al. delay
Humidity sensor - Min signal			h29	h29 RH Min Value
Humidity sensor - Max signal			h30	h30 RH Max Value
Humidity ctrl. at defrost	Select how to control humidity during defrost:No: Humidity control is stopped during defrostYes: Normal humidity control is running during defrost	0=No, 1=Yes	h28	h28 RH CtrlAtDef
Humidity max. temp.	Maximum limit for thermostat air temperature in order for humidity control to run (frost limit)		h32	h32 RH Max temp.
Humidity min. temp.	Minimum limit for thermostat air temperature in order for humidity control to run (frost limit)		h33	h33 RH Min temp.

Injection control

Table 32: Injection control

Function	Description	Values	Code	Short name
Control state A	Readout of the actual control state of the controller	0=Normal ctrl., 1=Hold after defrost, 2=Min ON timer, 3=Min OFF timer, 4=Drip off, 10=Main switch OFF, 11=Thermostat cut-out, 12=Frost protection S4, 14=Defrost, 15=Fan delay, 16=Forced closing, 17=Door open, 18=Melt period, 19=Modulating temp. control, 20=Emergency control, 23=Adaptive superheat control, 24=Start injection, 25=Manual control, 26=No refrigerant selected, 29=Case cleaning, 30=Forced cooling, 31=Door open, 32=Power-up delay, 33=Air heating, 45=Shut down controller, 48=Adaptive liquid control, 51=Oil recovery	u00	u00 Ctrl. state
Thermostat air temp. A	Thermostat temperature		u17	u17 Ther. air
S3 Air ON evap. A	Actual sensor value		u12	u12 S3 air temp.
S3 Air ON evap. B	Actual sensor value		u76	u76 S3 airtemp B
S4 Air OFF evap. A	Actual sensor value		u16	u16 S4 air temp.
EEV opening A	Actual status of output function		u23	u23 EEV OD %
Liquid line solenoid	Actual status of output function	0=OFF, 1=ON	U95	U95 LLSV
Pe Evap. pressure	Actual sensor signal		u25	u25 EvapPress Pe
Te Evap. temp.	Temperature converted from pressure		u26	u26 EvapTemp Te
S2 Gas outlet A	Actual sensor value		u20	u20 S2 temp.
Superheat A	Readout of actual superheat at the outlet of the evaporator		u21	u21 Superheat

AK-CC55 Single Coil and AK-CC55 Single Coil UI

Function	Description	Values	Code	Short name
Superheat reference A	Readout of the actual superheat reference		u22	u22 SuperheatRef
Min. superheat limit	Min. value for the superheat reference		n10	n10 Min SH
Max. superheat limit	Max. value for the superheat reference		n09	n09 Max SH
MOP temperature	MOP temperature. The valve opening degree is reduced until the evaporating temperature reaches the set MOP limit. If no MOP function is required, select the highest value that corresponds to OFF		n11	n11 MOP temp.
AKV Period time	Period time for the pulse width modulation		n13	n13 AKV Period
Min. superheat liquid ctrl A	Min. value for the superheat reference during adaptive liquid control		P87	P87 SH Min Liq.
Max. superheat liquid ctrl. A	Max. value for the superheat reference during adaptive liquid control		P86	P86 SH Max Liq.
LLSV closing delay	Closing delay for liquid line solenoid valve		P92	P92 LLSV OFF del
Oil recovery mode	Select how oil recovery is to be handled: 0 = None 1 = Adaptive liquid control with normal fan control 2 = Adaptive liquid control with fans OFF 3 = Fixed valve opening degree with normal fan control 4 = Fixed valve opening degree with fans OFF ⚠ WARNING: In option 3 and 4, superheat control is omitted and it is the responsibility of the user to safeguard the compressors.	0=None, 1=ALC and Fan ctrl, 2=ALC and Fan OFF, 3=Fixed OD and Fan ctrl, 4=Fixed OD and Fan OFF	x30	--- Oil rec mode
Max oil recovery time	Maximum time for an oil recovery cycle. If an oil recovery cycle lasts longer than the set time, the oil recovery cycle will be terminated		x31	--- Oil rec max
Oil recovery OD	Fixed valve opening degree during oil recovery Warning: Superheat control is omitted and it is the responsibility of the user to safeguard the compressors		x32	--- Oil rec OD%

Defrost control

Table 33: Defrost control

Function	Description	Values	Code	Short name
Control state A	Readout of the actual control state of the controller	0=Normal ctrl., 1=Hold after defrost, 2=Min ON timer, 3=Min OFF timer, 4=Drip off, 10=Main switch OFF, 11=Thermostat cut-out, 12=Frost protection S4, 14=Defrost, 15=Fan delay, 16=Forced closing, 17=Door open, 18=Melt period, 19=Modulating temp. control, 20=Emergency control, 23=Adaptive superheat control, 24=Start injection, 25=Manual control, 26=No refrigerant selected, 29=Case cleaning, 30=Forced cooling, 31=Door open, 32=Power-up delay, 33=Air heating, 45=Shut down controller, 48=Adaptive liquid control, 51=Oil recovery	u00	u00 Ctrl. state
Defrost sensor temperature A	Actual temperature of selected defrost stop sensor		U73	U73 Def.StopTemp
S5 Evaporator A	Actual sensor value		u09	u09 S5 temp.
S5 Evaporator B	Actual sensor value		u75	u75 S5 temp. B
Defrost A	Actual status of output function	0=OFF, 1=ON	u60	u60 Def. relay
Defrost B	Actual status of output function	0=OFF, 1=ON	u83	u83 Def. relay B
Defrost time A	Read the duration of the ongoing defrost or the duration of the last completed defrost.		u11	u11 Defrost time
Adaptive defrost state	Actual state of the adaptive defrost function	0=OFF, 1=Error, 2=Tuning, 3=OK, 4=Little ice, 5=Medium ice, 6=Heavy ice	U01	U01 AD state
Accumulated defrosts	Number of defrosts carried out since the initial power-up or since the resetting of the function		U10	U10 Acc.defrost
Accumulated skipped defrosts	Number of defrosts skipped since the initial power-up or since the resetting of the function		U11	U11 Acc.def.skip
Tc average temp.	Average value of the condensing temperature signal distributed via the system manager to the case controllers that are using adaptive defrost. At transcritical CO ₂ sites the receiver pressure is distributed to the case controllers. The function needs to be set up in the system manager.		x02	--- Tc temp. Ave
Start defrost	Command for starting a defrost	0=OFF, 1=ON	x09	--- Def. Start
Stop defrost	Command for stopping an ongoing defrost cycle	0=OFF, 1=ON	x10	--- Def. Stop

AK-CC55 Single Coil and AK-CC55 Single Coil UI

Function	Description	Values	Code	Short name
Defrost method	Select method of defrost	0=None, 1=Electrical, 2=Hot gas, 4=Air/Offcycle	d01	d01 Def. method
Defrost stop method	Here you define whether a defrost cycle is to be stopped by time or by a temperature sensor	0=Time, 1=S5 sensor, 2=S4 sensor, 3=S5A and S5B	d10	d10 DefStopSens.
Defrost stop limit 1	When the selected defrost stop sensor reaches the set limit, the defrost cycle is terminated		d02	d02 Def.StopTemp
Defrost stop limit 2	Defrost stop temperature limit when thermostat band 2 is in operation. When the selected defrost stop sensor reaches the set limit, the defrost cycle is terminated		d28	d28 DefStopTemp2
Min. defrost time	Minimum duration of a defrost cycle. The defrost cycle will as a minimum run for the set minimum defrost time once it is started		d24	d24 Min Def.time
Max. defrost time 1	Max duration of a defrost cycle. The setting is also used as a safety time if the defrost is stopped on temperature. If the selected defrost stop sensor does not reach the set defrost stop temperature limit within the set time, the defrost will be stopped anyway.		d04	d04 Max Def.time
Max. defrost time 2	Max duration of a defrost cycle when thermostat band 2 is in operation. The setting is also used as a safety time if the defrost is stopped on temperature. If the selected defrost stop sensor does not reach the set defrost stop temperature limit within the set time, the defrost will be stopped anyway.		d29	d29 MaxDefTime2
Defrost start interval	The function is zero set and will start the timer function at each defrost start. When the time has expired the function will start a defrost. The function is used as a simple defrost start, or it may be used as a safeguard if the normal signal fails to appear. If master/slave defrost without clock function or without data communication is used, the interval time will be used as max. time between defrosts. If a defrost start via data communication does not take place, the interval time will be used as max. time between defrosts. When there is defrost with clock function or data communication, the interval time must be set for a somewhat longer period of time than the planned one. In connection with power failure the interval time will be maintained, and when the power returns the interval time will continue from the maintained value. The interval time is not active when set to 0		d03	d03 Def.Interval
Time staggering power-up	Time staggering for defrost cut-ins during start-up. The function is only relevant if you have several refrigeration appliances or groups where you want the defrost to be staggered in relation to one another. The function is furthermore only relevant if you have chosen defrost with interval start. The function delays the interval time by the set number of minutes, but it only does it once, and this at the very first defrost taking place when voltage is connected to the controller. The function will be active after each and every power failure.		d05	d05 Time stagg.
Max. thermostat run time	Defrost on demand. Aggregate refrigeration time set here is the refrigeration time allowed without defrosts. If the time is passed, a defrost will be started. With setting = 0 the function is not in use.		d18	d18 MaxTherRunT.
Pump down delay	Set the time where the evaporator is emptied of refrigerant prior to the actual defrost cycle		d16	d16 Pump dwn del
Hot gas injection delay	Delay before opening hot gas valve		d23	d23 HotGasInjDel
Drip off time	Here you set the time that is to elapse from a defrost and until the compressor is to start again. (The time when water drips off the evaporator).		d06	d06 DripOff time
Max. hold time	Max. standby time after coordinated defrost. When a controller has completed a defrost it will wait for a signal telling that the refrigeration may be resumed. If this signal fails to appear for one reason or another, the controller itself will start the refrigeration when the standby time has elapsed.		o16	o16 MaxHoldTime
Drain delay	Drain delay (only in connection with hot gas). Set the time where the evaporator is emptied of condensed refrigerant after the defrost.		d17	d17 Drain delay

AK-CC55 Single Coil and AK-CC55 Single Coil UI

Function	Description	Values	Code	Short name
Fan control during defrost	Fan operation during defrost Here you can set how the fan is to operate during defrost. 0: Stopped (runs during pump down) 1: Running (stopped during "fan delay") 2: Running during pump down and defrost. After that stopped 3: Running during pump down and defrost until defrost stop sensor reaches fan stop temperature limit	0=OFF, 1=ON, 2=OFF at drip, 3=OFF at high temp	d09	d09 FanDuringDef
Fan stop temperature	If the fan control during defrost has been set up for it, the fans can be stopped during the defrost if the defrost sensor exceeds the set temperature limit		d41	d41 Def Fan Stop
Fan start delay	Delay of fan start after defrost. Here you set the time that is to elapse from compressor start after a defrost and until the fan may start again. (The time when remaining water is transformed into ice on the evaporator).		d07	d07 FanStartDel
Fan start temperature	Temperature limit for starting the fans after a defrost. When the measured S5 evaporator temperature is getting below the set limit, the fans are started		d08	d08 FanStartTemp
Rail heat during defrost	Define how rail heat is controlled during defrost 0: Rail heat is OFF all the time 1: Rail heat is ON all the time 2: Normal rail heat control	0=OFF, 1=ON, 2=Normal control	d27	d27 Railh.at def
Display delay after defrost	Set the maximum time the display should show the defrost code "-d-" after a defrost. The normal temperature readout is normally started when the temperature in the case is OK again or if a high temperature alarm is raised.		d40	d40 Disp. d del.
Adaptive defrost mode	Adaptive defrost is used to skip planned defrost cycles if they are not needed or in order to start an extra defrost when required 0: Not used 1: Monitors the evaporator and triggers an alarm in the case of icing up. 2: Scheduled defrosts during day time can be skipped. 3: Scheduled defrosts during day and night time can be skipped. 4: All schedules are carried out + extra if it is registered that this is required. (Temporary setting to OFF will reset the recorded values.)	0=OFF, 1=Monitoring, 2=Skip day, 3=Skip day/night, 4=Full adaptive	d21	d21 AD mode

Defrost schedules

Table 34: Defrost schedules

Function	Description	Values	Code	Short name
Defrost schedule		0=No, 1=Yes	t00	t00 Def.Schedule
Def. start 1 - Hours	Time in hours for start of defrost		t01	t01 Def. 1 hr.
Def. start 1 - Minutes	Time in minutes for when defrost cycle is to be started		t11	t11 Def. 1 min.
Def. start 2 - Hours	Time in hours for start of defrost		t02	t02 Def. 2 hr.
Def. start 2 - Minutes	Time in minutes for when defrost cycle is to be started		t12	t12 Def. 2 min.
Def. start 3 - Hours	Time in hours for start of defrost		t03	t03 Def. 3 hr.
Def. start 3 - Minutes	Time in minutes for when defrost cycle is to be started		t13	t13 Def. 3 min.
Def. start 4 - Hours	Time in hours for start of defrost		t04	t04 Def. 4 hr.
Def. start 4 - Minutes	Time in minutes for when defrost cycle is to be started		t14	t14 Def. 4 min.
Def. start 5 - Hours	Time in hours for start of defrost		t05	t05 Def. 5 hr.
Def. start 5 - Minutes	Time in minutes for when defrost cycle is to be started		t15	t15 Def. 5 min.
Def. start 6 - Hours	Time in hours for start of defrost		t06	t06 Def. 6 hr.
Def. start 6 - Minutes	Time in minutes for when defrost cycle is to be started		t16	t16 Def. 6 min.
Monday - Follow schedule		0=No, 1=Yes	t51	t51 Mon.Schedule
Tuesday - Follow schedule		0=No, 1=Yes	t52	t52 Tue.Schedule
Wednesday - Follow schedule		0=No, 1=Yes	t53	t53 Wed.Schedule

AK-CC55 Single Coil and AK-CC55 Single Coil UI

Function	Description	Values	Code	Short name
Thursday - Follow schedule		0=No, 1=Yes	t54	t54 Thu.Schedule
Friday - Follow schedule		0=No, 1=Yes	t55	t55 Fri.Schedule
Saturday - Follow schedule		0=No, 1=Yes	t56	t56 Sat.Schedule
Sunday - Follow schedule		0=No, 1=Yes	t57	t57 Sun.Schedule

Compressor

Table 35: Compressor

Function	Description	Values	Code	Short name
Compressor 1	Actual status of output function	0=OFF, 1=ON	u58	u58 Comp1/LLSV
Compressor 2	Actual status of output function	0=OFF, 1=ON	u67	u67 Comp2 relay
Min ON time	Minimum time the compressor is to run once it has been started.		c01	c01 Min. On time
Min OFF time	Minimum time the compressor has to be stopped		c02	c02 Min.Off time
Step control mode	Selection of step control mode for compressors. At sequential mode compressor 1 will always be the first to start and the last to stop. In cyclic mode the run time between the compressor will be equalized.	1=Sequential, 2=Cyclic	c08	c08 Step mode
Delay between comp.	Time delay for couplings of two compressors. The step delay is the time that has to elapse from the first compressor cuts in and until the next compressor can cut in.		c05	c05 Step delay
Comp. 2 ctrl. Th. band 2	Select whether compressor 2 is to be in operation in thermostat band 2	0=OFF, 1=ON	c85	c85 Cmp2 In Th2

Fan control

Table 36: Fan control

Function	Description	Values	Code	Short name
Control state A	Readout of the actual control state of the controller	0=Normal ctrl., 1=Hold after defrost, 2=Min ON timer, 3=Min OFF timer, 4=Drip off, 10=Main switch OFF, 11=Thermostat cut-out, 12=Frost protection S4, 14=Defrost, 15=Fan delay, 16=Forced closing, 17=Door open, 18=Melt period, 19=Modulating temp. control, 20=Emergency control, 23=Adaptive superheat control, 24=Start injection, 25=Manual control, 26=No refrigerant selected, 29=Case cleaning, 30=Forced cooling, 31=Door open, 32=Power-up delay, 33=Air heating, 45=Shut down controller, 48=Adaptive liquid control, 51=Oil recovery	u00	u00 Ctrl. state
Fan	Actual status of output function	0=OFF, 1=ON	u59	u59 Fan relay
Fan ECO	Actual status of output function	0=OFF, 1=ON	U37	U37 Fan Eco
Fan pulsing mode	Pulse operation of fan 0: No pulse operation 1: Pulse operation when the thermostat is cut out 2: Pulse operation when the thermostat is cut out, but only during night operation	0=No pulsing, 1=Pulsing cut-out, 2=Pulsing cut-out night	F05	F05 FanPulseMode
Fan period time	Period time for pulsing of fan		F06	F06 Fan cycle
Fan ON cycle	ON time for fan. The ON period is set as a percentage of the period time		F07	F07 Fan ON %
Fan stop high S5 temp.	Fan stop temperature The function stops the fans in an error situation, so that they will not provide power to the appliance. If the defrost sensor registers a higher temperature than the one set here, the fans will be stopped. There will be re-start at 2 K below the setting. The function is not active during a defrost or start-up after a defrost.		F04	F04 FanStop temp
Fan at forced closing	You can set whether fans should be operational or stopped if the function "Forced closing" is activated here. 0: Fans are OFF 1: Fans are ON 2: Fans are OFF and defrost is not permitted 3: Fans are ON and defrost is not permitted	0=OFF, 1=ON, 2=OFF and suppress defrost, 3=ON and suppress defrost	o90	o90 Fan ForcedCl
Fan stop at blinds closing	When blinds are closing the fans are stopped in the defined time delay in order to ensure that the blinds are closed correctly		P65	P65 BlindFanStop

Railheat control

Table 37: Railheat control

Function	Description	Values	Code	Short name
Control state A	Readout of the actual control state of the controller	0=Normal ctrl., 1=Hold after defrost, 2=Min ON timer, 3=Min OFF timer, 4=Drip off, 10=Main switch OFF, 11=Thermostat cut-out, 12=Frost protection S4, 14=Defrost, 15=Fan delay, 16=Forced closing, 17=Door open, 18=Melt period, 19=Modulating temp. control, 20=Emergency control, 23=Adaptive superheat control, 24=Start injection, 25=Manual control, 26=No refrigerant selected, 29=Case cleaning, 30=Forced cooling, 31=Door open, 32=Power-up delay, 33=Air heating, 45=Shut down controller, 48=Adaptive liquid control, 51=Oil recovery	u00	u00 Ctrl. state
Dewpoint	Actual dewpoint received from system manager via network		x18	--- Dew point
Rail heat	Actual status of output function	0=OFF, 1=ON	u61	u61 Railh. relay
Rail heat power	Readout of the actual rail power in %		u85	u85 Rail DutyC %
Rail heat PWM	Actual status of output function		U59	U59 Railheat PWM
Rail heat control mode	The rail heat can be controlled in several ways: 0: Rail heat is running all the time 1: Pulse control is used with a timer function following the day/night operation 2: Pulse control is used with a dewpoint function. This function requires that a signal is received about the dewpoint value. The value is measured by a system manager and sent to the controller via the data communication.	0=ON, 1=Day/Night timer, 2=Dewpoint ctrl.	o85	o85 Railh. mode
Rail heat ON cycle day	Rail heat power during day time. The ON period is set as a percentage of the period		o41	o41 Railh.ONday%
Rail heat ON cycle night	Rail heat power during night time. The ON period is set as a percentage of the period time		o42	o42 Railh.ONngt%
Rail heat period time	Period time for pulsing of rail heat		o43	o43 Railh.cycle
Rail heat PWM - Period time	Period time for the pulse width modulation		P82	P82 RailCyclePWM
Rail heat min. ON cycle	Lowest permitted rail heat power. When the measured dewpoint is below the defined minimum limit the rail heat will run with the set minimum power		o88	o88 Rail Min ON%
Dewpoint min. limit	If the measured dewpoint is below the set value the rail heat is running at minimum heat		o86	o86 DewP Min lim
Dewpoint max. limit	If the measured dewpoint is above the set value the rail heat is maximum		o87	o87 DewP Max lim

Light/Blinds/Cleaning control

Table 38: Light/Blinds/Cleaning control

Function	Description	Values	Code	Short name
Control state A	Readout of the actual control state of the controller	0=Normal ctrl., 1=Hold after defrost, 2=Min ON timer, 3=Min OFF timer, 4=Drip off, 10=Main switch OFF, 11=Thermostat cut-out, 12=Frost protection S4, 14=Defrost, 15=Fan delay, 16=Forced closing, 17=Door open, 18=Melt period, 19=Modulating temp. control, 20=Emergency control, 23=Adaptive superheat control, 24=Start injection, 25=Manual control, 26=No refrigerant selected, 29=Case cleaning, 30=Forced cooling, 31=Door open, 32=Power-up delay, 33=Air heating, 45=Shut down controller, 48=Adaptive liquid control, 51=Oil recovery	u00	u00 Ctrl. state
Night condition	Status of the day/night operation (night operation: on/off)	0=OFF, 1=ON	u13	u13 Night Cond.
Light	Actual status of output function	0=OFF, 1=ON	u63	u63 Light relay
Blinds	Actual status of output function	0=OFF, 1=ON	u82	u82 Blinds relay

AK-CC55 Single Coil and AK-CC55 Single Coil UI

Function	Description	Values	Code	Short name
Light control mode	Configuration of light function 1: Light is controlled via day/night status 2: Light is controlled via data communication and master control parameter "MC Light signal" 3: Light is controlled by door contact on DI input. When the door is opened the relay will cut in. When the door is closed again there will be a time delay of two minutes before the light is switched off. 4: As "2" but if there are any 15-minute network errors, the light will switch on and the night blind will open. 5: Light is controlled via DI input signal	1=Day and night, 2=Network, 3=Door switch, 4=Network (Fallback), 5=Digital input	o38	o38 Light config
Light at Main switch OFF	Define how light and blinds are to be controlled at Main switch OFF 0: Light is switched off and night blinds are open when the main switch is off 1: Light and night blinds are independent of main switch.	0=OFF, 1=Normal ctrl.	o98	o98 Light MS=Off
Blinds max. open time	Time delay from when blinds have been opened manually until they close again		P60	P60 BlindOpenTim
Case cleaning mode	The status of the function can be seen here or the function can be started manually. 0 = Normal operation (no cleaning) 1 = Only fans are running to defrost the evaporator. All other outputs are Off. 2 = Cleaning with stopped fans. All outputs are Off. If the function is controlled by a digital input signal, the relevant status can be seen here in the menu.	0=OFF, 1=Fans run, 2=Cleaning	o46	o46 Case clean

Display control

Table 39: Display control

Function	Description	Values	Code	Short name
Control state A	Readout of the actual control state of the controller	0=Normal ctrl., 1=Hold after defrost, 2=Min ON timer, 3=Min OFF timer, 4=Drip off, 10=Main switch OFF, 11=Thermostat cut-out, 12=Frost protection S4, 14=Defrost, 15=Fan delay, 16=Forced closing, 17=Door open, 18=Melt period, 19=Modulating temp. control, 20=Emergency control, 23=Adaptive superheat control, 24=Start injection, 25=Manual control, 26=No refrigerant selected, 29=Case cleaning, 30=Forced cooling, 31=Door open, 32=Power-up delay, 33=Air heating, 45=Shut down controller, 48=Adaptive liquid control, 51=Oil recovery	u00	u00 Ctrl. state
Display readout 1	Readout of the temperature shown on the display		u56	u56 Display air
Display readout 2	Readout of the temperature shown on the display		U35	U35 Display air2
Display readout	Select which temperature to show in the display	1=Display air, 2=S6 Product temp.	o97	o97 Displ. Ctrl.
Display air S4%	Signal to the display sensor. Here you have to define the ratio between the sensors which the display has to use. S3, S4 or a combination of the two. With setting 0% only S3 is used. With 100% only S4 is used		o17	o17 Disp. S4 %
Display readout adjustment	Correction of the display's temperature. If the temperature at the products and the temperature received by the controller are not identical, an offset adjustment of the display temperature can be carried out.		r04	r04 Disp. Adj. K
Temperature unit	Select whether temperatures are to be shown as °C or as °F.	0=Celsius, 1=Fahrenheit	r05	r05 Temp.unit
Display keyboard lock	With this setting it is possible to lock the keyboard operation of the local display. None: Display keyboard operation will never be locked. Local: When not used for some time, the local display will lock the keyboard operations and a special key combination is required in order to enable the keyboard operations. Network: When the controller receives a master control signal (--- Key/BT lock) via the network, the display keyboard operations will be locked. The keyboard operations can only be activated again by setting the master control signal OFF via the System Manager.	0=None, 1=Local, 2=Network	P89	P89 LockDispKey

Alarm relay priorities

Table 40: Alarm relay priorities

Function	Description	Values	Code	Short name
Alarm relay	Actual status of output function	0=OFF, 1=ON	u62	u62 Alarm relay
Alarm relay priority	Set which alarm priorities that are to activate the alarm relay: 0=Not used, alarm relay is not used 1: High. Alarm with high priority will activate relay 2: Medium. Alarms with high or medium priority will activate the alarm relay 3: All. All alarms will activate alarm relay	0=Not used, 1=High Priority, 2=Medium priority, 3=All	P41	P41 Al.Rel.Prio
Mute alarm	When muting alarms, the alarm relay will stop signaling the alarm until a new alarm arises	0=OFF, 1=ON	q38	q38 Mute Alarm
High temperature - Priority	Select the priority of the alarms associated to the alarm group. Be aware - by selecting "Disable" the alarms will not be shown on the display or be routed to the alarm relay or to the network.	0=Disabled, 3=Low, 2=Medium, 1=High	q28	q28 Hi Temp Prio
Low temperature - Priority	Select the priority of the alarms associated to the alarm group. Be aware - by selecting "Disable" the alarms will not be shown on the display or be routed to the alarm relay or to the network.	0=Disabled, 3=Low, 2=Medium, 1=High	q29	q29 Lo Temp Prio
Sensor errors - Priority	Select the priority of the alarms associated to the alarm group. Be aware - by selecting "Disable" the alarms will not be shown on the display or be routed to the alarm relay or to the network.	0=Disabled, 3=Low, 2=Medium, 1=High	q30	q30 Sensor Prio
DI alarms - Priority	Select the priority of the alarms associated to the alarm group. Be aware - by selecting "Disable" the alarms will not be shown on the display or be routed to the alarm relay or to the network.	0=Disabled, 3=Low, 2=Medium, 1=High	q31	q31 DIAlarm Prio
Defrost - Priority	Select the priority of the alarms associated to the alarm group. Be aware - by selecting "Disable" the alarms will not be shown on the display or be routed to the alarm relay or to the network.	0=Disabled, 3=Low, 2=Medium, 1=High	q32	q32 Defrost Prio
Miscellaneous - Priority	Select the priority of the alarms associated to the alarm group. Be aware - by selecting "Disable" the alarms will not be shown on the display or be routed to the alarm relay or to the network.	0=Disabled, 3=Low, 2=Medium, 1=High	q33	q33 Misc Prio
Injection - Priority	Select the priority of the alarms associated to the alarm group. Be aware - by selecting "Disable" the alarms will not be shown on the display or be routed to the alarm relay or to the network.	0=Disabled, 3=Low, 2=Medium, 1=High	q34	q34 Inject Prio
Control stopped - Priority	Select the priority of the alarms associated to the alarm group. Be aware - by selecting "Disable" the alarms will not be shown on the display or be routed to the alarm relay or to the network.	0=Disabled, 3=Low, 2=Medium, 1=High	q35	q35 CtrlOFF Prio
Leak detection - Priority	Select the priority of the alarms associated to the alarm group. Be aware - by selecting "Disable" the alarms will not be shown on the display or be routed to the alarm relay or to the network.	0=Disabled, 3=Low, 2=Medium, 1=High	q36	q36 Leak Prio
Humidity ctrl. - Priority	Select the priority of the alarms associated to the alarm group. Be aware - by selecting "Disable" the alarms will not be shown on the display or be routed to the alarm relay or to the network.	0=Disabled, 3=Low, 2=Medium, 1=High	q37	q37 Humid Prio

Miscellaneous

Table 41: Miscellaneous → Access codes

Function	Description	Values	Code	Short name
Access code 3	Access code for local display		o05	o05 Acc. code 3
Access code 2	Access code for local display		o64	o64 Acc. code 2
Access code 1	Access code for local display		P88	P88 Acc. code 1

Table 42: Miscellaneous → Network

Function	Description	Values	Code	Short name
Network status	Quality of the network communication		U45	U45 Comm. status
Network address	Network address of the controller		o03	o03 Unit addr.
Baudrate	Communication speed of network	1=Auto, 2=9600 Baud, 3=19200 Baud, 4=38400 Baud	x96	--- Bus baudrate
Parity and stop bit	Select parity and stop bit of Modbus messages	0=None, 1=Even, 2=Odd	x97	--- Parity bit

Table 43: Miscellaneous → Sensor adjustment

Function	Description	Values	Code	Short name
S2 Gas outlet A - Adjustment	Correction of sensor signal e.g. due to long sensor cable		r19	r19 Adjust S2
S3 Air ON evap. A - Adjustment	Correction of sensor signal e.g. due to long sensor cable		r10	r10 Adjust S3
S4 Air OFF evap. A - Adjustment	Correction of sensor signal e.g. due to long sensor cable		r09	r09 Adjust S4
S3 Air ON evap. B - Adjustment	Correction of sensor signal e.g. due to long sensor cable		r53	r53 Adjust S3 B
S5 Evaporator A - Adjustment	Correction of sensor signal e.g. due to long sensor cable		r11	r11 Adjust S5
S6 product temp. - Adjustment	Correction of sensor signal e.g. due to long sensor cable		r59	r59 Adjust S6

Table 44: Miscellaneous → Factory reset

Function	Description	Values	Code	Short name
Reset to factory settings	Command which will revert all controller settings to factory values.	0=OFF, 1=ON	z06	--- Reset factory
Make new factory	With this command you save the controller's actual settings as a new basic setting (the earlier factory settings are overwritten).	0=OFF, 1=ON	o67	o67 Make factory

Advanced

Table 45: Advanced → Advanced injection control

Function	Description	Values	Code	Short name
Superheat ctrl. mode A	Select how to control the superheat of the evaporator. At adaptive control the superheat reference is adapted automatically to give the best utilization of the evaporator surface. At load based control the superheat reference is increased at high loads	1=Adaptive, 2=Load based	n21	n21 SH mode
Superheat close A	Minimum superheat limit where the valve is closing		x68	--- SH close
AFidentForce A	Expert setting - contact Danfoss for further information		x69	--- AFidentForce
Superheat Kp min. A	Min limit for amplification factor of the PI controller adjusting the valve opening degree (expert setting)		x70	--- SH Kp min
Superheat Kp max. A	Max limit for amplification factor of the PI controller adjusting the valve opening degree (expert setting)		x71	--- SH Kp max
Superheat Tn A	Integration time of the PI controller adjusting the valve opening degree (expert setting)		x72	--- SH Tn
S2 stability A	Setting required stability of S2 gas outlet temperature before the superheat reference is reduced (Expert setting)A higher value will allow more instability in S2 signalA lower value will allow less instability in S2 signal		Y33	--- S2 Stability
S2 Std deviation	Expert readout - contact Danfoss for further information		Y34	--- S2 Std dev
Te feedback gain A	Gain factor for feedback of evaporating temperature signal Te to the PI controller controlling the superheat (expert setting)		x73	--- Te-gain
Kp MTR control A	Amplification factor for modulating temperature control (Expert setting)		x77	--- MTR Kpfactor
Tn MTR control A	Integration time for modulating temperature control (Expert setting)		x78	--- MTR Tn sec
AFident A	Expert readout - contact Danfoss for further information		x79	--- AFident
Calculated Max OD A	Calculated maximum opening degree of the injection valve (expert readout)		x80	--- Max OD %
Superheat close liquid ctrl. A	Minimum limit of superheat where the valve is closing during adaptive liquid control		x87	--- SH close Liq
AFident Ee	Expert readout - contact Danfoss for further information		Y20	--- AFident Ee
Aver.OD Ee	Expert readout - contact Danfoss for further information		Y21	--- Aver.OD Ee
SH Band	Expert injection setting - contact Danfoss for further information		Y28	--- SH band
Ther. duty cycle SP	Expert setting - contact Danfoss for further information		Y29	--- ThDutyCycle

AK-CC55 Single Coil and AK-CC55 Single Coil UI

Function	Description	Values	Code	Short name
Ther. duty cycle	Expert setting - contact Danfoss for further information		Y30	--- ActDutyCycle
P-gain	Expert injection setting - contact Danfoss for further information		Y31	--- P-gain
OD Ctrl. status	Readout showing which part of the injection function that is in control of the valve opening degree	Values must be changed as per below: 0=Adaptive SH control 1=MOP 2=Superheat close 3=MTR	Y32	--- OD status

Table 46: Advanced → Advanced adaptive defrost control

Function	Description	Values	Code	Short name
AD sensibility	Expert setting - contact Danfoss for further information		Z06	--- AD sense
Flash gas sense	Expert setting - contact Danfoss for further information		x89	--- FlashGasSens
Air tuning value	Expert setting - contact Danfoss for further information		x90	--- AD AirTuning
New air tuning value	Expert readout - contact Danfoss for further information		x92	--- NewAirTunVal
Little ice indicator	Expert readout - contact Danfoss for further information		Y04	--- FaultIndic.0
Medium ice indicator	Expert readout - contact Danfoss for further information		x91	--- FaultIndic.1
Heavy ice indicator	Expert readout - contact Danfoss for further information		Y05	--- FaultIndic.2
Flash gas indicator	Expert readout - contact Danfoss for further information		x93	--- Fl.Gas.Indic
AD int. state	Expert readout - contact Danfoss for further information		Y11	--- ADintState
Time constant Lpf	Expert setting - contact Danfoss for further information		Y19	--- TimeConstLpf
DefrostOut			Y24	DefrostOut
AirTuneValR			Y26	AirTuneValR
IceLevel			Y27	IceLevel

Table 47: Advanced → Master control

Function	Description	Values	Code	Short name
Control state A	Readout of the actual control state of the controller	0=Normal ctrl., 1=Hold after defrost, 2=Min ON timer, 3=Min OFF timer, 4=Drip off, 10=Main switch OFF, 11=Thermostat cut-out, 12=Frost protection S4, 14=Defrost, 15=Fan delay, 16=Forced closing, 17=Door open, 18=Melt period, 19=Modulating temp. control, 20=Emergency control, 23=Adaptive superheat control, 24=Start injection, 25=Manual control, 26=No refrigerant selected, 29=Case cleaning, 30=Forced cooling, 31=Door open, 32=Power-up delay, 33=Air heating, 45=Shut down controller, 48=Adaptive liquid control, 51=Oil recovery	u00	u00 Ctrl. state
Regulation condition A	Readout of the actual control state of the controller	0=Main switch OFF, 1=Injection start, 2=Superheat ctrl., 3=Fill evap., 4=Defrost, 5=Post defrost, 6=Forced closing, 7=Injection fault, 8=Emergency control, 9=Modulating ctrl., 10=Melt period, 11=Door open, 12=Case cleaning, 13=Cutout, 14=Forced cooling, 15=Shut down	x62	--- Reg. Cond.
MC Actual cut-in temp.			x63	--- Cutin temp.
MC Actual cut-out temp.			x64	--- Cutout temp.
MC Ther. toggle	Master control signal used for switching case load ON/OFF depending on the load condition	0=No action, 1=Toggle ON, 2=Toggle OFF	x81	--- TherToggle
MC Load request	Master control signal used to control the load balance between multiple case controllers on the same suction line		x82	--- LoadReq
MC Max. Te offset	Requested offset to actual evaporating temperature in order to keep the air temperature at the actual set-point		x84	--- MaxTeOffset
MC Liquid control	Master control signal allowing switch to adaptive liquid control	0=OFF, 1=ON	x85	--- MC Liq. Ctrl

Function	Description	Values	Code	Short name
MC Night setback	Master control signal for changing between day and night time operation	0=OFF, 1=ON	x06	--- Night setback
MC Case shutdown	Master control signal used to shut down a case for a time period. During shutdown there will be no alarm monitoring	0=OFF, 1=ON	x17	--- Case shutdwn
MC Forced closing	Master control signal that will close the injection valve	0=OFF, 1=ON	x07	--- Forced close
MC Forced cooling	Master control signal that will provide forced cooling	0=OFF, 1=ON	x08	--- Forced cool.
MC Defrost start	Master control signal for starting a defrost. At adaptive defrost the defrost might be skipped if the defrost is not needed	0=OFF, 1=ON	x13	--- MC def.start
MC Defrost state	Read out the actual state of the defrost	0=OFF, 1=ON	x14	--- DefrostState
MC Hold after defrost	Master control signal used for co-ordinated defrost control to hold cabinets from returning to normal refrigeration after a defrost until all cabinets have terminated defrost	0=OFF, 1=ON	x11	--- HoldAfterDef
MC Stop defrost	Master control signal used to prevent a defrost start in a controller.	0=OFF, 1=ON	x12	--- Disable def.
MC Request next defrost	Master control signal used by system manager to see if a controller is requesting that the next defrost has to be carried out	0=No, 1=Yes	x94	--- AD def.req.
MC Light signal	Master control signal for control of light via a data communication signal from the system manager	0=OFF, 1=ON	o39	o39 Light remote
MC Actual dewpoint	Master control signal sending the actual measured dewpoint from the system manager to the controller over the network.		x03	--- Act.DewPoint
MC Tc temp. mean	Master control signal distributing the condensing temperature signal to the case controllers that are using adaptive defrost. At transcritical CO2 sites the receiver pressure is distributed to the case controllers. This function needs to be set up in the system manager.		x04	--- TcTempMean
MC Po load factor			x83	--- Load factor
MC Key/Bluetooth lock	Master control signal that will lock down all Bluetooth data communication and optionally also the operation of the display keys (depends on selection in P89 Display keyboard lock)	0=OFF, 1=ON	x33	--- Key/BT lock
MC Min. delta T	Required minimum delta temperature across evaporator (S3 - Te) in order to keep the air temperature at the actual setpoint		y04	--- Min Delta T
MC Oil recovery	Master control signal for starting and stopping a oil recovery cycle	0=OFF, 1=ON	x29	--- Oil recov.

Fault message

In an error situation the alarm LED on the front will be on and the alarm relay will be activated (depending on priority). If you push the alarm button for 3 seconds you can see the alarm report in the display. (Alarm priorities can be changed. See [Table 40: Alarm relay priorities.](#)) Here are the messages that may appear:

Table 48: Fault message

Code	Alarm text	Description
E01	Hardware failure	The controller has a hardware failure
E06	Clock lost time	Clock has lost valid time
E20	Pe Evap. pressure A - Sensor error	Sensor signal is out of range. Please check the sensor for correct operation
E24	S2 Gas outlet A - Sensor error	Sensor signal is out of range. Please check the sensor for correct operation
E25	S3 Air ON evap. A - Sensor error	Sensor signal is out of range. Please check the sensor for correct operation
E26	S4 Air OFF evap. A - Sensor error	Sensor signal is out of range. Please check the sensor for correct operation
E27	S5 Evaporator A - Sensor error	Sensor signal is out of range. Please check the sensor for correct operation
E28	S6 product temp. A - Sensor error	Sensor signal is out of range. Please check the sensor for correct operation
E34	S3 Air ON evap. B - Sensor error	Sensor signal is out of range. Please check the sensor for correct operation
E37	S5 Evaporator B - Sensor error	Sensor signal is out of range. Please check the sensor for correct operation
E59	Humidity sensor - Sensor error	Sensor signal is out of range. Please check the sensor for correct operation
A01	High temperature alarm A	The alarm temperature has been above the max alarm limit for a longer time period than the set alarm delay.
A02	Low temperature alarm A	The alarm temperature has been below the min alarm limit for a longer time period than the set alarm delay.
A04	Door open alarm	The door has been open for a too long time
A05	Max defrost hold time exceeded	The controller has been waiting longer time than permitted after a co-ordinated defrost.

AK-CC55 Single Coil and AK-CC55 Single Coil UI

Code	Alarm text	Description
A11	Refrigerant not selected	The refrigerant has not been selected hence control can not be initiated
A13	S6 high product temperature A	The S6 Product temperature has been above the max alarm limit for a longer time period than the set alarm delay.
A14	S6 low product temperature A	The S6 Product temperature has been below the min alarm limit for a longer time period than the set alarm delay.
A15	DI alarm 1	Alarm signal from digital input signal
A16	DI alarm 2	Alarm signal from digital input signal
A45	Main switch set OFF	The controller main switch has been set to either Stop or Manual control. Alternatively a digital input set up for "main switch" function, has stopped control
A59	Case in cleaning mode	A case cleaning operation has been started on a case
A70	High temperature alarm B	The alarm temperature has been above the max alarm limit for a longer time period than the set alarm delay.
A71	Low temperature alarm B	The alarm temperature has been below the min alarm limit for a longer time period than the set alarm delay.
AA2	CO ₂ leak detected	CO ₂ is leaking from the refrigeration system
AA3	Refrigerant leak detected	Refrigerant is leaking from the refrigeration system
a02	High humidity alarm	The humidity level is too high
a03	Low humidity alarm	The humidity level is too low
a04	Wrong IO configuration	Inputs and outputs have not been configured correctly
X02	Evaporator is icing up	The adaptive defrost function has detected heavy ice formation on evaporator.
X03	Flash gas detected	The adaptive defrost function has detected heavy flash gas in front of injection valve
Z01	Max defrost time exceeded A	The last defrost cycle has stopped on time instead of set temperature
A34	Fan alarm	Alarm from digital input monitoring function
A43	Valve driver alarm	Alarm from digital input monitoring function

i NOTE:

Data communication

The importance of individual alarms can be defined with a setting. The setting must be carried out in the group "Alarm destinations".

Operating status

Table 49: Operating status

Ctrl. State/ Code	Operating status	Description
		Push the info button for 3 seconds to see status. If there is a status code, it will be shown on the display. The individual status codes have the following meanings:
S0	Normal ctrl.	The controller is running normal control. There is no other control taking priority
S1	Hold after defrost	The controller is waiting for other controllers to terminate coordinated defrost
S2	Min ON timer	The compressor is restricted from stopping until the minimum ON timer expires
S3	Min OFF timer	The compressor is restricted from starting until the minimum OFF timer expires
S4	Drip off	The defrost has terminated and the controller is waiting for drip delay to expire, while the water is dripping off the evaporator
S10	Main switch OFF	The controller has been stopped because the parameter r12 Main switch has been set in OFF or Service position or the controller has been stopped via Main switch function on DI input
S11	Thermostat cut-out	The air temperature has reached the thermostat cut-out value
S12	Frost protection S4	The air off temperature is below the minimum S4 frost limit (r98, S4 frost protection)
S14	Defrost	The controller is running a defrost cycle
S15	Fan delay	The evaporator fans are waiting to start after a defrost cycle (d07, Fan start delay and d08, Fan start temperature)
S16	Forced closing	The injection valve has been forced closed via a signal on a digital input or from the system manager (compressor pack is restricted from starting)
S17	Door open	DI signal indicates that the cold room door is open
S18	Melt period	The controller has stopped refrigeration for a short while to turn ice crystals into water and thereby improve air flow through the evaporator
S19	Modulating temp. control	The air temperature is controlled close to the set point via a modulating temperature control
S20	Emergency control ⁽¹⁾	The air temperature is controlled according to an emergency procedure due to sensor error (Pe, S2, S3 or S4)
S23	Adaptive superheat control	The superheat of the evaporator is optimized
S24	Start injection	The liquid injection into the evaporator has started
S25	Manual control	Main switch has been set in Service position for manual control of outputs
S26	No refrigerant selected	The refrigerant type has not been selected (parameter o30 Refrigerant)
S29	Case cleaning	A case cleaning operation has been initiated via parameter o46 Case cleaning mode or via a signal on a digital input or via the AK-CC55 Connect app
S30	Forced cooling	The thermostat has been overruled to run forced cooling via a signal on a digital input
S32	Power-up delay	The controller has just been powered up and the output control is waiting for the power-up delay to expire (parameter o01, Delay of outputs at power-up)
S33	Air heating	The air heater is energized in order to raise the air temperature (parameters r62, Air heater neutral zone and r63, Air heater start delay)
S45	Shut down controller	The control has been stopped due to a digital input signal or from the system manager
S48	Adaptive liquid control	The superheat control is running adaptive liquid control with reduced superheat for transcritical CO ₂ systems with ejectors. Signal is provided via digital input or from the system manager
S50	Oil recovery	The controller is running an oil recovery sequence

⁽¹⁾ Emergency control:

- If Pe or S2 sensor fails, the controller will operate with a safe opening degree based on normally registered opening degree during day and night operation.
- If S3 or S4 sensor fails, the thermostat will operate with a registered ON/OFF duty cycle during day and night operation.

Product specification

Technical data

Electrical specifications

Table 50: Electrical specifications

Electrical data	Value
Supply voltage AC [V]	115 V / 230 V, 50/60 Hz
Power consumption [VA]	5 VA
Power ON indicator	Green LED
Electrical cable dimensioning [mm ²]	Max. 1.5 mm ² multi-core cable

Sensor and measuring data

Table 51: Sensor and measuring data

Sensor and measuring data	Value
Sensor S2, S6	Pt 1000 AKS11
Sensor S3, S4, S5	Pt 1000 AKS11 PTC 1000 EKS111 NTC5K EKS211 NTC10K EKS221 sensor (All 3 must be of the same type)
Temperature measuring accuracy	Pt1000: -60 – 120 °C. ±0.5 K PTC1000: -60 – 80 °C. ±0.5 K NTC5K: -40 – 80 °C. ±1.0 K NTC10K: -40 – 120 °C. ±1.0 K
Pt1000 sensor specification	±0.3 K at 0 °C ±0.005 K per degree
Pe measuring	AKS 32R Ratiometric pressure transmitter: 10-90%
RH measuring	0 – 10 V Ri > 10K ohm Accuracy +/- 0,3% FS

Input and output relay specifications

Table 52: Input and output relay specifications

Input and output relay specifications	Input/output	Description
Digital input	DI1 DI2	Signal from dry contact functions Requirements to contacts: Gold plating Cable length must be max. 15 m Use auxiliary relays when the cable is longer Open loop: 12 V (SELV) Contact 3,5 mA
Digital input	DI3	115 V / 230 V AC
Solid state output	DO1 (for AKV coil)	115V / 230 V AC Max. 0.5 A Max. 1 x 20 W AKV for 115 V AC 2 x 20 W AKV for 230 V AC Note: 2 EC coils are not supported.
Relays	DO2 DO3 DO4 DO5 DO6	115 V / 230 V AC Load max.: CE. 8 (6)A UL. 8A res. 3FLA 18LRA Load min.: 1VA Inrush: DO5 DO6 TV-5 80A
Analogue output/ PWM	AO1	0 / 10 V Pulse Width Modulated (PWM) max. 15 mA. 0 – 10 V variable, max. 2 mA

AK-CC55 Single Coil and AK-CC55 Single Coil UI

NOTE:

- DO2 to DO6 are 16 A relays.
- Max. load must be observed.
- DO5 / DO6 is recommended for load with high inrush current e.g. EC Fan and LED light.
- All relays are sealed for use with flammable refrigerant like Propane R290.
- Compliance with EN 60 335-2-89: 2010 Annex BB.

Function data

Table 53: Function data

Function data	Value
Display	LED 3 digit
External display, AK-CC55 Single Coil UI	1 external display
External display, AK-CC55 Single Coil	2 external displays
External display connection	RJ12
Max. display cable length [m]	100 m
Data communication built-in	MODBUS
Data communication option	AK-OB55 Lon RS485 module (Not AK-CC55 Compact)
Clock battery backup power reserve	4 days
Mounting	DIN rail

Environmental conditions

Table 54: Environmental conditions

Environmental conditions	Value
Ambient temperature range, transport [°C]	0 – 55 °C
Ambient temperature range, storage [°C]	-40 – 70 °C
Enclosure rating IP	IP20
Relative humidity range [%]	20 – 80%, non-condensing
Shocks/Vibrations	No shocks and vibrations allowed

Dimensions

Measurements are in mm.

Figure 59: AK-CC55 Single Coil

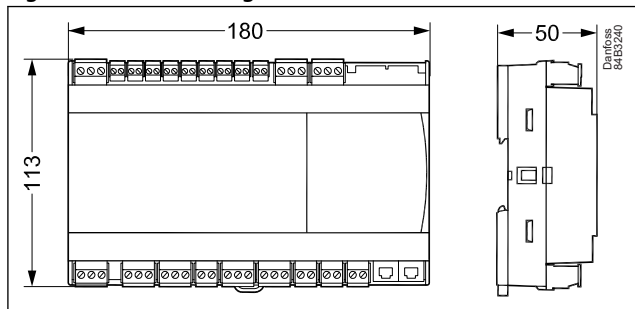

Figure 60: AK-CC55 Single Coil UI

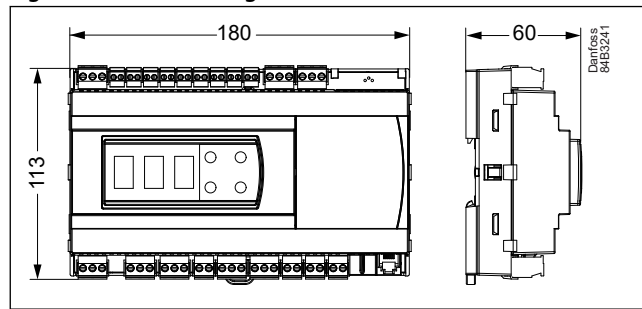

Figure 61: AK-UI55 Set

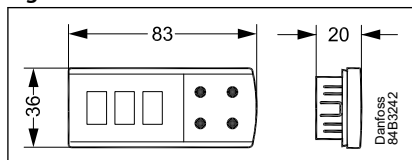
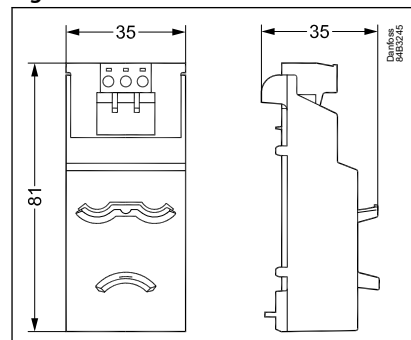

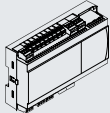
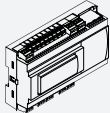



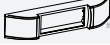

Figure 62: AK-OB55



Ordering

The list contains the components that make up an AK-CC55 Single Coil setup. For other Danfoss products mentioned in the document, such as sensors and valves, refer to relevant product documentation.

Table 55: Ordering

Type	Symbol	Function	Code no.
AK-CC55 Single Coil		Case controller for one AKV valve	084B4082
AK-CC55 Single Coil UI		Case controller for one AKV valve Integrated display with control buttons	084B4083
AK-UI55 Info		External display	084B4077
AK-UI55 Bluetooth		External display with Bluetooth operation	084B4075
AK-UI55 Set		External display with control buttons	084B4076
AK-UI55 Mounting Base		Mounting kit for display types: AK-UI55 Set, AK-UI55 Bluetooth, AK-UI55 Info	084B4099
AK-UI cable		External display cable with RJ12 connector. 3 m	084B4078
AK-UI cable		External display cable with RJ12 connector. 6 m	084B4079
AK-OB55 Lon		Data communication module Lon Can be mounted in Single Coil and Multi Coil versions	084B4070
MMIMYK		Gateway between AK-CC55 and PC installed with KoolProg software	080G0073

Certificates, declarations, and approvals

The list contains all certificates, declarations, and approvals for this product type. Individual code number may have some or all of these approvals, and certain local approvals may not appear on the list.

Some approvals may change over time. You can check the most current status at danfoss.com or contact your local Danfoss representative if you have any questions.

Table 56: Controller

Control	Certification	Mark	Country
Single Coil / Single Coil UI	EMC/LVD/RoHS	CE	EU
Single Coil/Single Coil UI	UL recognized	cURus	NAM (US and Canada)
Single Coil / Single Coil UI	ACMA (EMC)	RCM	Australia/New Zealand
Single Coil / Single Coil UI	LVE/EMC/RoHS	EAC	Russia, Kazakhstan, belarus
Single Coil / Single Coil UI	LVD/EMC/RoHS	UA	Ukraine

Table 57: Display module

Display module	Certification	Mark	Country
AK-UI55 Bluetooth	RED	CE	EU
AK-UI55 Bluetooth	FCC	FCC ID	USA
AK-UI55 Bluetooth	IC (ISED)	IC ID	Canada
AK-UI55 Bluetooth	CMIIT	CMITT ID	China
AK-UI55 Bluetooth	ACMA (EMC/Wireless)	RCM	Australia
AK-UI55 Bluetooth	RSM (EMC/Wireless)	RCM	New Zealand
AK-UI55 Bluetooth	EMC/LVD/Wireless	UA	Ukraine
AK-UI55 Bluetooth	ANATEL	ANATEL ID	Brazil
AK-UI55 Bluetooth	SUBTEL	N/A	Chile
AK-UI55 Bluetooth	RoHS	EAC	Russia, Kazakhstan, Belarus
AK-UI55 Info	EMC/LVD	UA	Ukraine
AK-UI55 Info	ACMA (EMC)	RCM	Australia
AK-UI55 Info	RSM (EMC)	RCM	New Zealand
AK-UI55 Info	RoHS	EAC	Russia, Kazakhstan, belarus
AK-UI55 Set	EMC/LVD	UA	Ukraine
AK-UI55 Set	ACMA (EMC)	RCM	Australia
AK-UI55 Set	RSM (EMC)	RCM	New Zealand
AK-UI55 Set	RoHS	EAC	Russia, Kazakhstan, belarus

Table 58: Option module

Option module	Certification	Mark	Country
AK-OB55 LoN	EMC/LVD	UA	Ukraine

Controllers/displays/option module:

CB certificate including all deviation according to IEC 60730-1 and 2-9

Relays:

Tested according to IEC 60079-15

Statements for the AK-UI55 Bluetooth display

FCC COMPLIANCE STATEMENT

⚠ CAUTION:

Changes or modifications not expressly approved could void your authority to use this equipment. This device complies with Part 15 of the FCC Rules. Operation is subject to the following two conditions: (1) This device may not cause harmful interference, and (2) this device must accept any interference received, including interference that may cause undesired operation.

INDUSTRY CANADA STATEMENT

This device complies with Industry Canada license-exempt RSS standard(s). Operation is subject to the following two conditions: (1) this device may not cause interference, and (2) this device must accept any interference, including interference that may cause undesired operation of the device.

Le présent appareil est conforme aux CNR d'Industrie Canada applicables aux appareils radio exempts de licence. L'exploitation est autorisée aux deux conditions suivantes : (1) l'appareil ne doit pas produire de brouillage, et (2) l'utilisateur de l'appareil doit accepter tout brouillage radioélectrique subi, même si le brouillage est susceptible d'en compromettre le fonctionnement.

Online support

Danfoss offers a wide range of support along with our products, including digital product information, software, mobile apps, and expert guidance. See the possibilities below.

The Danfoss Product Store



The Danfoss Product Store is your one-stop shop for everything product related—no matter where you are in the world or what area of the cooling industry you work in. Get quick access to essential information like product specs, code numbers, technical documentation, certifications, accessories, and more.

Start browsing at store.danfoss.com.

Find technical documentation



Find the technical documentation you need to get your project up and running. Get direct access to our official collection of data sheets, certificates and declarations, manuals and guides, 3D models and drawings, case stories, brochures, and much more.

Start searching now at www.danfoss.com/en/service-and-support/documentation.

Get local information and support



Local Danfoss websites are the main sources for help and information about our company and products. Find product availability, get the latest regional news, or connect with a nearby expert—all in your own language.

Find your local Danfoss website here: www.danfoss.com/en/choose-region.

AK-CC55 Connect



Make service easy with the free AK-CC55 Connect app. Via a Danfoss Bluetooth display you can connect to an AK-CC55 case controller and get a visual overview of the display functions. The app ensures smooth interaction with a Danfoss AK-CC55 case controller in a user-friendly design.

Download the app here:



Play Store



App Store

Any information, including, but not limited to information on selection of product, its application or use, product design, weight, dimensions, capacity or any other technical data in product manuals, catalogues descriptions, advertisements, etc. and whether made available in writing, orally, electronically, online or via download, shall be considered informative, and is only binding if and to the extent, explicit reference is made in a quotation or order confirmation. Danfoss cannot accept any responsibility for possible errors in catalogues, brochures, videos and other material. Danfoss reserves the right to alter its products without notice. This also applies to products ordered but not delivered provided that such alterations can be made without changes to form, fit or function of the product. All trademarks in this material are property of Danfoss A/S or Danfoss group companies. Danfoss and the Danfoss logo are trademarks of Danfoss A/S. All rights reserved.