

Data sheet

Thermostat, Differential thermostat RT



An RT thermostat is fitted with a single-pole changeover switch.

The position of the contacts depends on the bulb temperature and the set scale value.

The RT series includes thermostats for general applications within industrial and marine refrigeration.

The RT series also includes differential thermostats, thermostats for neutral zone regulation and special thermostats with gold-plated contact surface for PLC applications.

Features

- Waterproof versions, enclosure IP66
- Wide regulating range
- Wide range of units for industrial and marine applications
- Suitable for alternating and direct current
- Interchangeable contact system
- Special versions for PLC applications
- Safety Integrity Level: SIL 2 according to IEC 61508

Approvals

RT 2	RT 3	RT 4	RT 7	RT 8	RT 8L	RT 9	RT 11	RT 12	RT 13	RT 14	RT 14L	RT 15	RT 16L	RT 17	RT 23	RT 24	RT 34	RT 101	RT 102	RT 107	RT 140	RT 140L	RT 270		
																									Lloyd's Reg. of Shipping, LR
	•			•	•	•		•	•	•	•	•						•		•					Germanischer Lloyd, GL
																			•		•				Det Norske Veritas, DNV
																			•						Bureau Veritas, BV
•	•	•	•	•	•	•	•	•	•	•	•	•	•	•	•	•	•	•	•	•	•	•	•	•	Russian Maritime Register of Shipping, RMRS
•	•		•					•	•	•		•			•				•		•				Nippon Kaiji Kyokai, NKK
																					•				Korean Register of Shipping, KRS
•	•	•	•	•	•	•	•	•	•	•	•	•	•	•	•	•	•	•	•	•	•	•	•	•	Conformity with EN 60730-2-1 to 9
•	•	•	•	•	•	•	•	•	•	•	•	•	•	•	•	•	•	•	•	•	•	•	•	•	CE mark according to EN 60947-4, -5
•	•	•	•	•	•	•	•	•	•	•	•	•	•	•	•	•	•	•	•	•	•	•	•	•	China Compulsory Certificate, CCC

Technical data

Cable connection	Pg 13.5. Cable diameter 6 – 14 mm.
Enclosure	IP66 acc. to EN 60529 / IEC 60529, except for versions with ext. reset which are IP54.
Permissible ambient temperature	-50 – 70 °C for thermostat housing.
Switches	See "Ordering switches"

Properties according to EN 60947

Wire dimensions	
solid / stranded	0.2 – 2.5 mm ²
flexible, w / out ferrules	0.2 – 2.5 mm ²
flexible, with ferrules	0.2 – 1.5 mm ²
Tightening torque	max. 1.5 Nm
Rated impulse voltage	4 kV
Pollution degree	3
Short circuit protection, fuse	10 A
Insulation	400 V
Ingress Protection	IP54, IP66

Data sheet | Thermostat, Differential thermostat, type RT

Overview

[-50, 0, 50, 100, 150, 200, 250, 300] [°C]		Range [°C]	Type
	Vapour-charged with remote bulb (bulb coldest)	-45 – -15	RT 9
		-30 – 0	RT 13
		-25 – 15	RT 3
		-25 – 15	RT 2, RT 7
		-20 – 12	RT 8
		-5 – 10	RT 12
		-5 – 30	RT 14
	Adsorption-charged with remote bulb (bulb warmest or coldest)	5 – 22	RT 23
		8 – 32	RT 15
		15 – 34	RT 24
		15 – 45	RT 140
		25 – 90	RT 101, RT 102
	Partial charge with remote bulb (bulb warmest)	70 – 150	RT 107
		-50 – -15	RT 17
	Vapour-charged with coiled capillary tube sensor (room thermostats)	-30 – 0	RT 11
	-5 – 30	RT 4	
Adsorption-charged with coiled capillary tube sensor (room thermostats)	-25 – 15	RT 34	
	-20 – 12	RT 8L	
Adsorption-charged dead zone thermostats with remote bulb (bulb warmest or coldest)	-5 – 30	RT 14L	
	15 – 45	RT 140L	
Vapour-charged dead zone thermostat (room thermostat)	0 – 38	RT 16L	
Adsorption-charged differential thermostats with remote bulb (bulb warmest or coldest)	-30 – 40	RT 270	

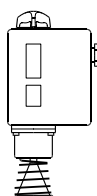
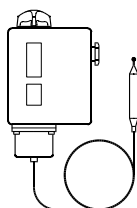
Ordering

Thermostats

Charge	Type	Bulb type	Regulation range [°C]	Differential Δt		Reset	Max. bulb temp. [°C]	Capillary tube length [m]	Code no.
				At min. range setting [K]	At max. range setting [K]				
Vapour ¹⁾	RT 9	A	-45 – 15	2.2 – 10.0	1.0 – 4.5	auto	150	2	017-506666
	RT 3	A	-25 – 15	2.8 – 10.0	1.0 – 4.0	auto	150	2	017-501466
	RT 17	B	-50 – -15	2.2 – 7.0	1.5 – 5.0	auto	100	–	017-511766
	RT 11	B	-30 – 0	1.5 – 6.0	1.0 – 3.0	auto	66	–	017-508366
	RT 4	B	-5 – 30	1.5 – 7.0	1.2 – 4.0	auto	75	–	017-503666 017-503766 ⁴⁾
Adsorption ²⁾	RT 13	A	-30 – 0	1.5 – 6.0	1.0 – 3.0	auto	150	2	017-509766
	RT 2	A	-25 – 15	5.0 – 18.0	6.0 – 20.0	auto	150	2	017-500866
	RT 8	A	-20 – 12	1.5 – 7.0	1.5 – 7.0	auto	145	2	017-506366
	RT 12	A	-5 – 10	1.0 – 3.5	1.0 – 3.0	auto	65	2	017-508966
	RT 23	A	5 – 22	1.1 – 3.5	1.0 – 3.0	auto	85	2	017-527866
	RT 15	A	8 – 32	1.6 – 8.0	1.6 – 8.0	auto	150	2	017-511566
	RT 24	A	15 – 34	1.4 – 4.0	1.4 – 3.5	auto	105	2	017-528566
	RT 140	C	15 – 45	1.8 – 8.0	2.5 – 11.0	auto	240	2	017-523666
	RT 102	D	25 – 90	2.4 – 10.0	3.5 – 20.0	auto	300	2	017-514766
	RT 34	B	-25 – 15	2.0 – 10.0	2.0 – 12.0	auto	100	–	017-511866
	RT 7	A	-25 – 15	2.0 – 10.0	2.5 – 14.0	auto	150	2	017-505366
RT 14	A	-5 – 30	2.0 – 8.0	2.0 – 10.0	auto	150	2	017-509966	
RT 101	A	25 – 90	2.4 – 10.0	3.5 – 20.0	auto	300	2	017-500366	
Partial ³⁾	RT 107	A	70 – 150	6.0 – 25.0	1.8 – 8.0	auto	215	2	017-513566

¹⁾ The sensor must be located colder than thermostat housing and capillary tube.

²⁾ The sensor can be located warmer or colder than thermostat housing.

³⁾ The sensor must be located warmer than thermostat housing and capillary tube.

⁴⁾ With built-in heating coil – reduces the thermal differential

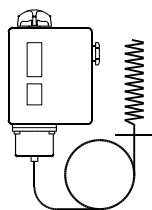
Thermostats with adjustable dead zone

Charge	Type	Bulb type	Regulation range [°C]	Mechanical differential [K]	Neutral zone NZ		Max. bulb temp. [°C]	Capillary tube length [m]	Code no.
					At min. range setting [K]	At max. range setting [K]			
Vapour	RT 16L	B	0 – 38	1.5 – 0.7	1.5 – 5.0	0.7 – 1.9	100	–	017L002466
Adsorption	RT 8L	A	-20 – 12	1.5	1.5 – 4.4	1.5 – 4.9	145	2	017L003066
	RT 14L	A	-5 – 30	1.5	1.5 – 5.0	1.5 – 5.0	150	2	017L003466
	RT 140L	C	15 – 45	1.8 – 2.0	1.8 – 4.5	2.0 – 5.0	240	2	017L003166
	RT 101L	A	25 – 90	2.5 – 3.5	2.5 – 7.0	3.5 – 12.5	300	2	017L006266

Data sheet | Thermostat, Differential thermostat, type RT

Ordering
Continued

Type of bulb / sensor

A	B	C	D
Cylindrical remote sensor	Room sensor	Duct sensor	Capillary tube sensor

Special versions

RT can be supplied with special switches.
See next page.







When ordering, please state:

1. Type
2. Code no. of standard unit
3. Code no. of special switch

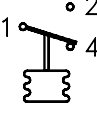
Switches

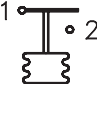
Version	Symbol	Description	Contact rating	Reset	Code no.
Standard		Single-pole changeover switch with terminal board proof against leakage current. Fitted in all standard versions of type RT. Snap action changeover contacts.		Auto	017-403066
Man. reset		For manual reset of unit after contact changeover on rising temperature. For units with reset facility.	Alternating current <i>Ohmic:</i> AC 1 = 10 A, 400 V	Max.	017-404266
Man. reset		For manual reset of unit after contact changeover on falling temperature. For units with reset facility.	<i>Inductive:</i> AC 3 = 4 A, 400 V AC 15 = 3 A, 400 V <i>Dir. current:</i> DC 13 = 12 W, 220 V	Min.	017-404166
Neutral zone		Single-pole changeover switch with dead zone and terminal board proof against leakage current.		–	Available only as a component part of RT controls with adjustable neutral zone

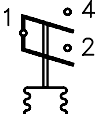
Ordering
(continued)
Switches

Version	Symbol	Description	Contact rating	Reset	Code no.	
Standard	 SPDT	Single-pole changeover switch with gold plated (oxide-free) contact surfaces. Increases cut-in reliability on alarm and monitoring systems, etc. Snap action changeover contacts. Terminal board proof against leakage current.		Auto	017-424066	
Man. reset	 SPDT	Single-pole changeover switch with gold plated (oxide-free) contact surfaces. Increases cut-in reliability on alarm and monitoring systems, etc. Snap action changeover contacts. Terminal board proof against leakage current.		Max.	017-404866	
Neutral zone	 SPDT	Single-pole changeover switch with dead zone and gold plated (oxide-free) contact surfaces. Increase cut-in reliability on alarm and monitoring systems, etc. Snap action changeover contacts. Terminal board proof against leakage current.		<i>Inductive:</i> AC 3 = 2 A, 400 V AC 15 = 1 A, 400 V <i>Dir. current:</i> DC 13 = 12 W, 220 V	–	Available only as a component part of RT controls with adjustable neutral zone
Man. reset	 SPDT	Single-pole changeover switch with gold plated (oxide-free) contact surfaces. Increases cut-in reliability on alarm and monitoring systems, etc. Snap action changeover contacts. Terminal board proof against leakage current.			Min.	017-404766
Cuts in two circuits simultaneously	 SPST	Single-pole changeover switch that cuts in two circuits simultaneously on rising temperature. Snap action changeover contacts. Terminal board proof against leakage current.	Alternating current <i>Ohmic:</i> AC 1 = 10 A, 400 V <i>Inductive:</i> AC 3 = 3 A, 400 V AC 15 = 2 A, 400 V <i>Dir. current:</i> DC 13 = 12 W, 220 V ¹⁾	Max.	017-403466	
With non-snap action change-over contacts	 SPDT	Single-pole changeover switch with non-snap action changeover contacts.	<i>Alternating or direct current</i> 25 VA, 24 V	–	017-018166	

¹⁾ If current is led through contacts 2 – 4, i.e. terminals 2 – 4 connected but not 1, max. permissible load is increased to 90 W, 220 V.

The switches are shown in the position they assume on falling temperature, i.e. after downward movement of the RT main spindle. The setting pointer of the control shows the scale value at which contact changeover occurs on falling temperature.

Spare parts and accessories,
see separate spare parts catalogue.

An exception is RT with switch, code no. **017-404266**, with max. reset where the setting pointer shows the scale value at which contact changeover occurs on rising temperature.

Design / Function

- 5. Setting knob
- 9. Regulation range scale
- 10. Loop terminal
- 11. Pg 13.5 screwed cable entry
- 12. Main spring
- 14. Terminals
- 15. Main spindle
- 16. Switch
- 17. Upper guide bush
- 18. Contact arm
- 19. Differential temperature setting nut
- 23. Bellows element
- 25. Fixing hole
- 26. Sensor (bulb) clip
- 28. Capillary tube
- 29. Sensor (bulb)
- 30. Sensor (bulb) pocket
- 31. Capillary tube gland
- 38. Earth terminal
- 44. Temperature setting spindle

Key sketch of RT thermostat

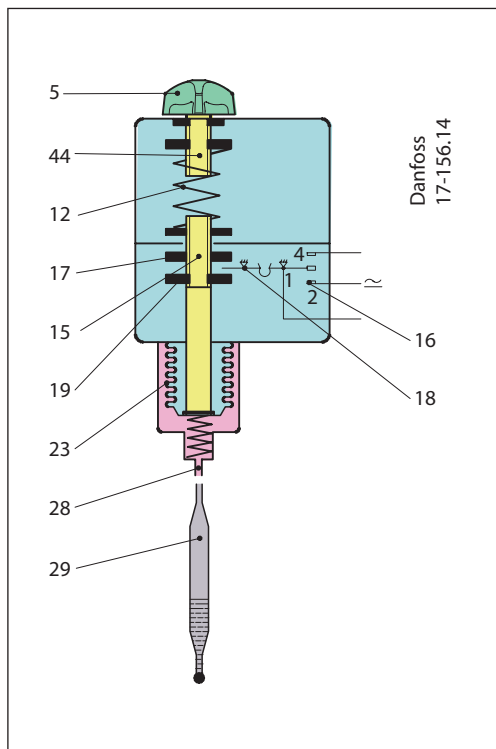

The thermostatic element consists of a sensor (29) capillary tube (28) and bellows element (23). The element contains a charge that reacts to temperature variations at the sensor so that the pressure on the moving bellows rises when temperature rises. By turning the setting knob (5) the main spring (12) can be set to balance the pressure in the element.

RT thermostat

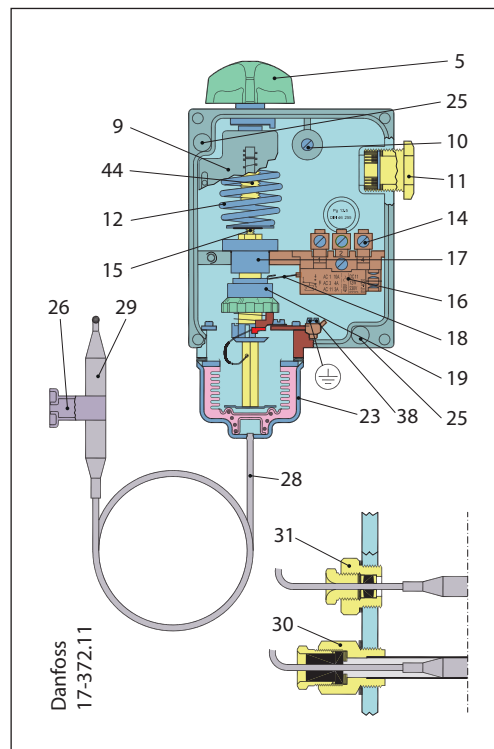

A rise in temperature at the sensor compresses the bellows and moves the main spindle (15) upwards until spring force and element pressure are in equilibrium. The main spindle (15) is fitted with a guide bush (17) and a differential setting nut (19) that together transfer the main spindle movement to the switch (16).

Design / Function
(continued)

- 5. Setting knob
- 9. Regulation range scale
- 12. Main spring
- 15. Main spindle
- 16. Switch
- 17. Upper guide bush
- 18a and 18b. Contact arm
- 20. Lower guide bush
- 23. Bellows element
- 25. Fixing hole
- 28. Capillary tube
- 29. Sensor (bulb)
- 40. Neutral zone setting nut
- 44. Temperature setting spindle

Key sketch RT L thermostat with neutral zone

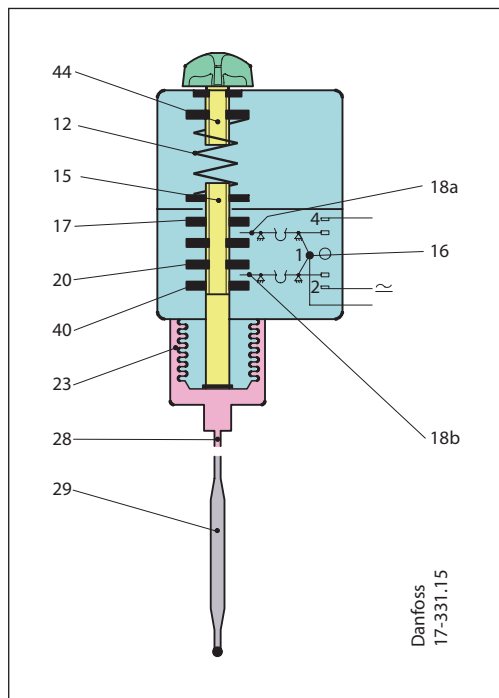

RT L thermostat with neutral zone

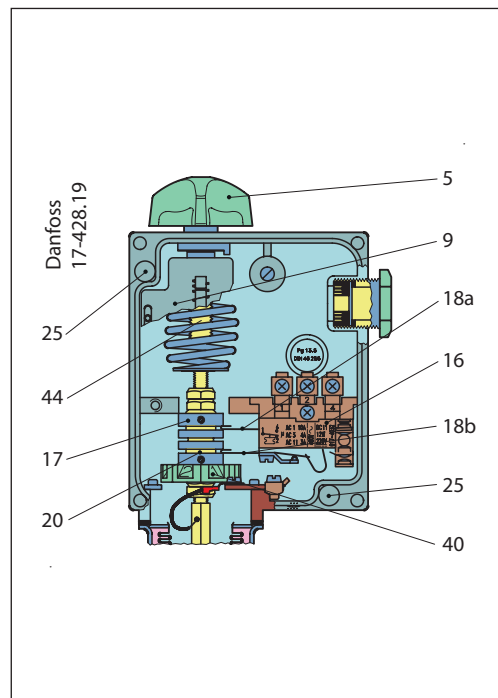

RT L thermostats are fitted with a switch with an adjustable neutral zone. This enables the units to be used for floating control. The neutral zone switch contact arms (18a) and (18b) are operated by the spindle guide bushes (17) and (20).

The upper guide bush (17) is fixed while the lower guide bush (20) can be moved up or down by the setting nut (40). In this way the neutral zone can be varied between a minimum value (equal to the mechanical differential of the unit) and a maximum value (depending on the type of RT unit).

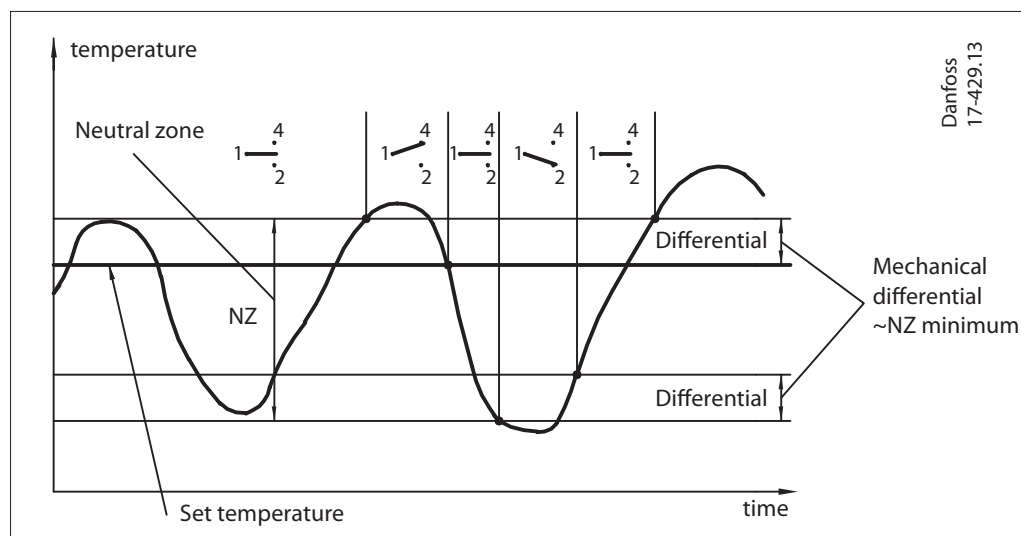

Terminology

Floating control

A form of delayed control where the correcting element (e.g. valve, damper, or similar) moves towards one extreme position at a rate independent of the magnitude of the error when the error exceeds a definite positive value, and towards the opposite extreme position when the error exceeds a definite negative value.

Hunting

Periodic variations of the controlled variable from the fixed reference.

Neutral zone

The interval between the make points of the two contacts.

Charges

1. Vapour charge

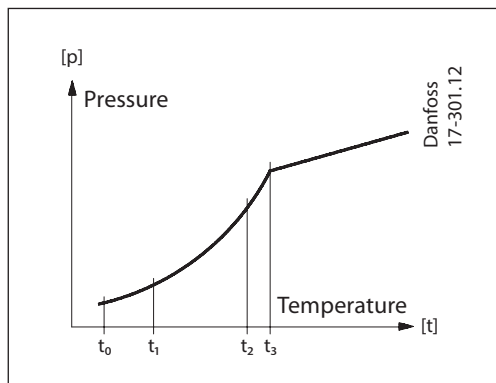

Here the interdependence between the pressure and temperature of saturated vapour is utilized, i.e. the element is charged with saturated vapour plus a small amount of liquid.

The charge is pressure-limited; a further increase in pressure after evaporation of all the liquid in the bulb, will only result in a small pressure increase in the element.

This principle can be utilized in thermostats for low temperature, etc., where evaporation must be able to take place from the free liquid surface in the bulb (within the operation range of the thermostat), and where at the same time, the bellows must be protected against deformation when kept at normal ambient temperatures. Since the pressure in the element depends on the temperature at the free liquid surface, the thermostat must always be placed so that the bulb is colder than the rest of the thermostatic element.

The evaporated liquid will recondense at the coldest point, i.e. the bulb. Thus, as intended, the bulb becomes the temperature-controlling element in the system.

Note:

When the bulb is coldest, the ambient temperature has no effect on regulating accuracy.

2. Adsorption charge

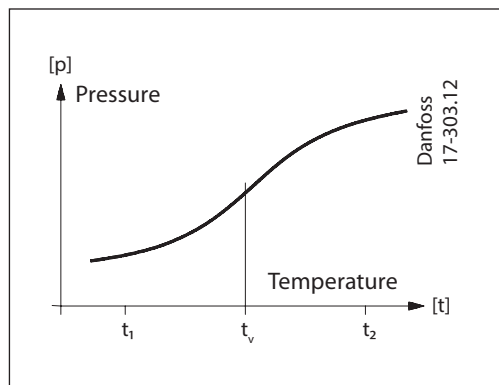

In this case the charge consists partly of a superheated gas and partly of a solid having a large adsorption surface.

The solid is concentrated in the bulb and it is therefore always the bulb that is the temperature-controlling part of the thermostatic element.

The bulb can thus be placed warmer or colder than the rest of the thermostatic element. Such a charge is however to some extent sensitive to changes in the temperature of the bellows element and capillary tube.

Under normal conditions this is not important, but if the thermostat is used in extreme conditions, scale deviation will occur. The scale can be corrected by using the graph and the table.

Scale correction = $Z \times a$.

Z can be found in the graph and "a" in the table.

Scale deviation factor

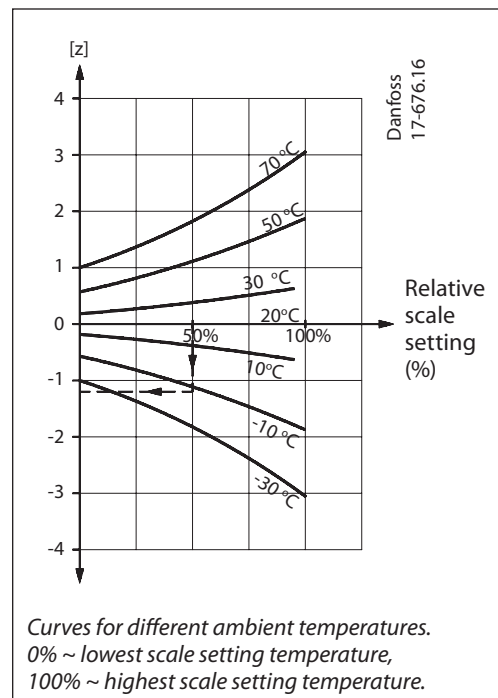

Curves for different ambient temperatures. 0% ~ lowest scale setting temperature, 100% ~ highest scale setting temperature.

Type	Range [°C]	Correction factor "a"
RT 2	-25 – 15	2.3
RT 7	-25 – 15	2.9
RT 8, RT 8L	-20 – 12	1.7
RT 12	-5 – 10	1.2
RT 14, RT 14L	-5 – 30	2.4
RT 15	8 – 32	1.2
RT 23	5 – 22	0.6
RT 24	15 – 34	0.8
RT 101, RT 102	25 – 90	5.0
RT 140, RT 140L	15 – 45	3.1

Charges
(continued)

Example
Scale correction on an RT 14 (range -5 – 30 °C) at activating temperature 12 °C and ambient temperature -10 °C.
The scale temperature, 12 °C, lies approximately in the middle of the scale range, i.e. relative scale setting of 50%.
The factor Z can be found in the graph from 50% and the curve for -10 °C, i.e. approx. -1.2.

The correction factor “a” can be found in the table for an RT 14, i.e. 2.4.
The scale correction = $Z \times a = -1.2 \times 2.4 = -2.88$.
If activation at 12 °C for the same conditions is required, the thermostat must be set at $12 \times 2.88 = 9.12 \approx 9.1$.

3. Partial charge

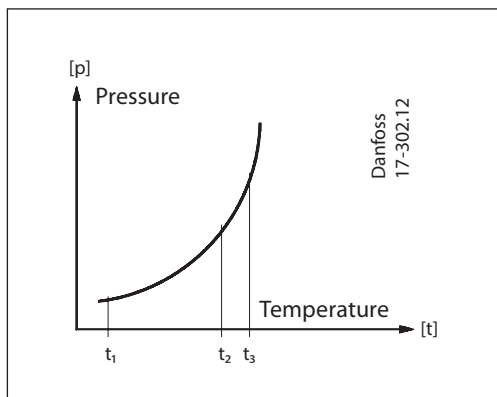

Partial charge is used in RT units having a range lying higher than ambient temperature.
As with the vapour charge, the partial charge utilizes the interdependence between the pressure and temperature of saturated vapour.

The partial charge is of such a volume that the bellows housing, capillary tube and a small part of the bulb are filled when the thermostat is in operation. The bulb is thus the warmest part of the system.
The liquid will condense in the remaining, coldest, part of the system but because of the volume of the charge the free liquid surface will always be in the bulb. In this way, the bulb becomes the temperature-controlling part of the system.

Note:
When the bulb is placed warmest, the ambient temperature has no effect on regulating accuracy.

Design / Function

RT differential thermostat

- 1. LT sensor (bulb)
- 2. Capillary tube
- 4. LT bellows element
- 5. Setting disc
- 9. Regulation range scale
- 10. Loop terminal
- 11. Pg 13.5 screwed cable entry
- 12. Main spring
- 14. Terminals
- 15. Main spindle
- 16. Switch
- 17. Upper guide bush
- 18. Contact arm
- 20. Lower guide bush
- 24. HT bellows element
- 25. Fixing hole
- 28. Capillary tube
- 32. HT sensor (bulb)
- 38. Earth terminal
- 39. Blow-out disc

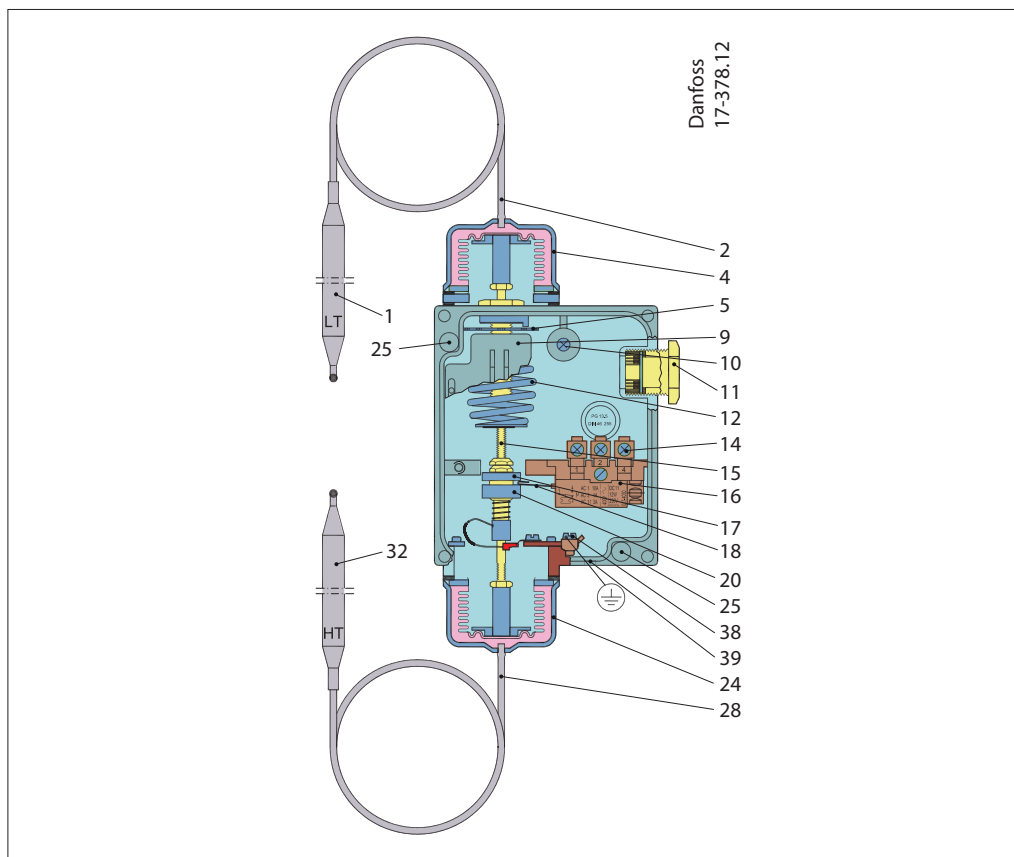

An RT differential thermostat contains a single-pole changeover switch that makes or breaks depending on the temperature difference between the two sensors of the unit.

The RT 270 017D003166 is for use in process plant, ventilation plant, and refrigeration and heating plant where there is need to maintain a certain temperature differential, 0 – 15 °C, between two media. One sensor is used as a reference and the other as a control sensor. The temperature differential is the direct controlled variable.

Within the operating range the RT 270 can be set for different temperature differentials by the setting disc (5).

When the differential between LT and HT sensor temperature falls, the main spindle (15) moves downwards.

The contact arm (18) is moved downwards by the guide (17) so that contacts (1-4) break and contacts (1-2) make when the set temperature differential is reached.

The contacts changeover again when the temperature differential rises to the set value plus the fixed contact differential of approx. 2 °C.

The figure shows a cross-section of the RT 270.

The differential thermostat contains two bellows elements: the LT element whose sensor must be placed in the medium having the lowest temperature, and the HT element whose sensor must be placed in the medium having the highest temperature.

The main spring has a rectilinear characteristic.

Example

Set differential = 4 °C.

Switch breaks at 4 °C differential and remakes at 4+2=6 °C.

Terminology

Regulation range

The temperature differential between LT and HT sensors within which the unit can be set to operate. Indicated on the thermostat scale.

Scale indication

The difference between the temperature on LT and HT sensors at the moment when the switch contacts change over as a result of the downward movement of the spindle.

Operating range

The temperature range of the LT sensor, within which the differential thermostat can operate.

Contact differential

The temperature rise on the HT sensor over the set temperature differential which causes the switch contacts to make or break.

Reference sensor

The sensor that is placed in the medium whose temperature is not affected by the function of the thermostat (HT or LT sensor).

Control sensor

The sensor that is placed in the medium whose temperature must be controlled (LT or HT sensor).

Setting of differential

The knob can be used to make a setting on the range scale for the lowest temperature at which the contact system must be activated (cut-out or cut-in).

The differential roller 19 must then be used to set the differential. The highest activating temperature at the sensor is equal to the activating temperature + the set differential.

Nomograms for obtained differentials

RT 2

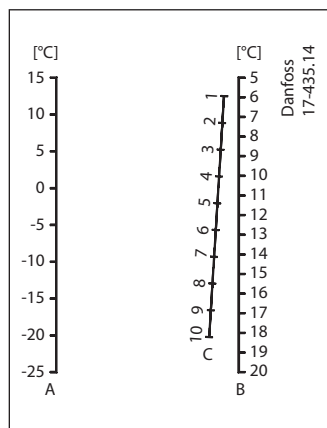

RT 3

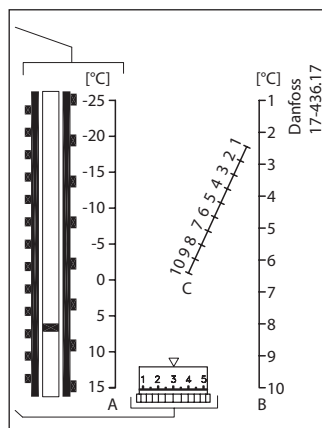

RT 4

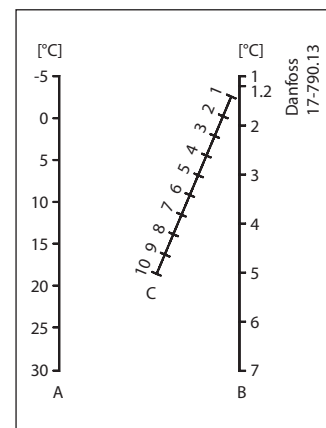

RT 7

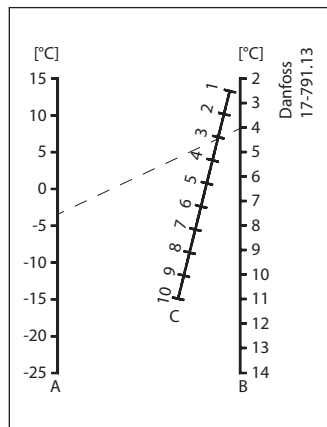

RT 9

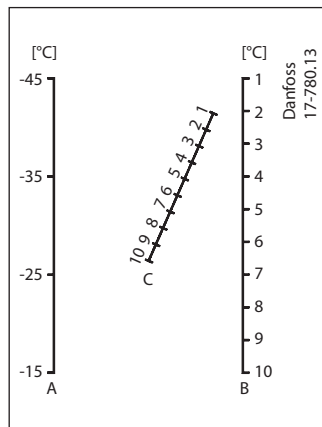

RT 10

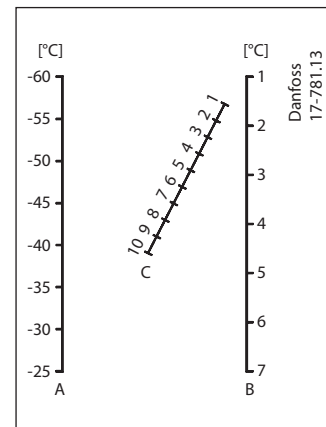

RT 11, RT 13

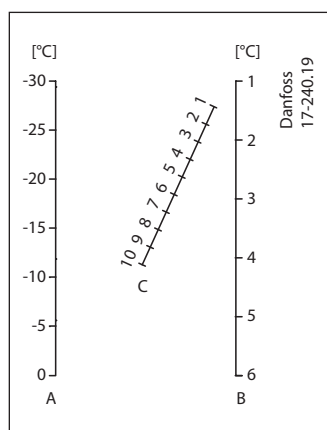

RT 12

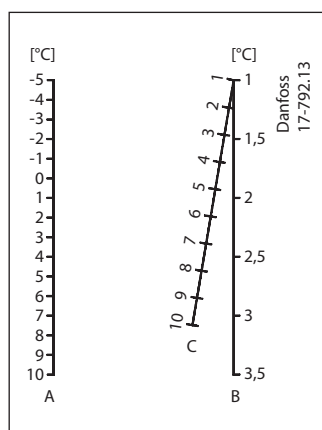

RT 24

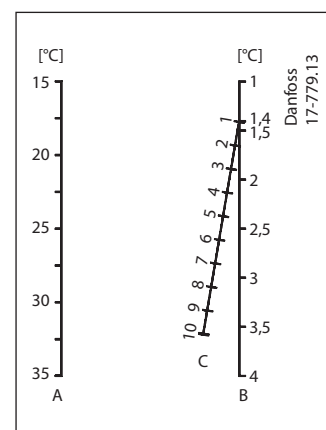

A = Range setting
 B = Obtained differential
 C = Differential setting

Nomograms for obtained differentials
(continued)

RT 14

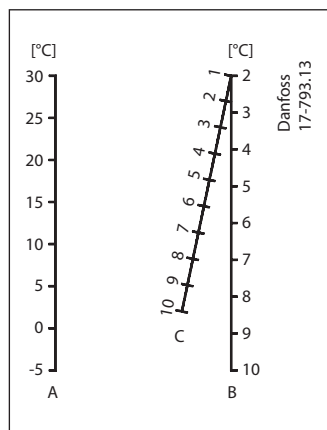

RT 17

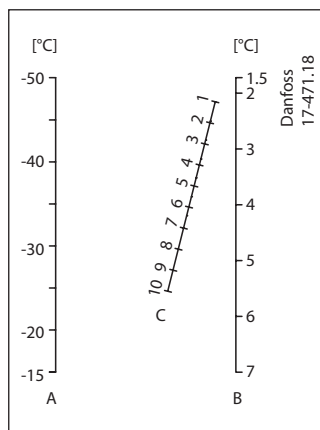

RT 23

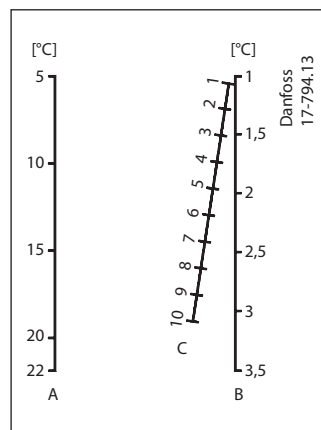

RT 34

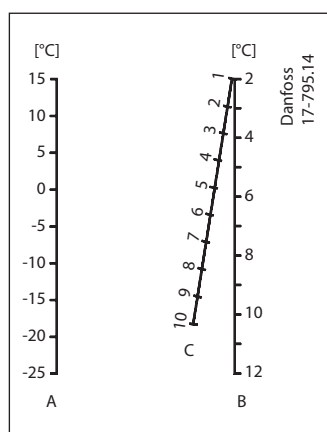

RT 101

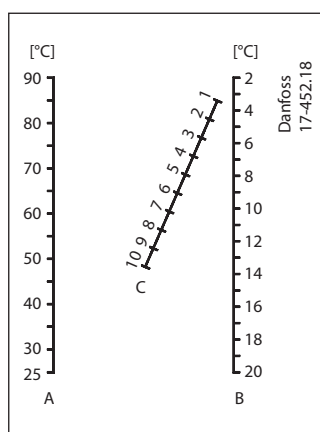

RT 107

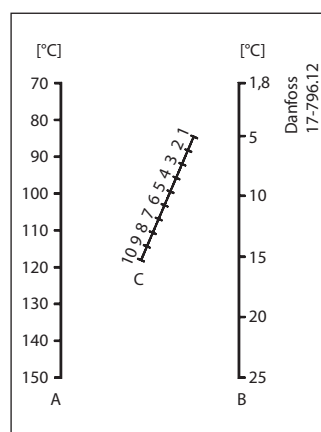

RT 140

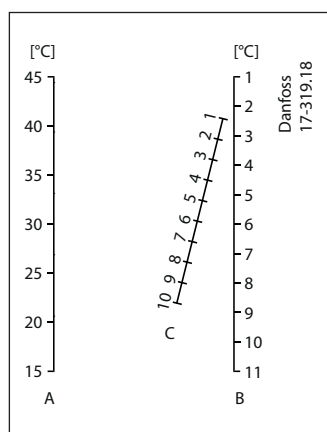

A = Range setting
B = Obtained differential
C = Differential setting

Dimensions [mm]
and weights [kg]

RT thermostat housing

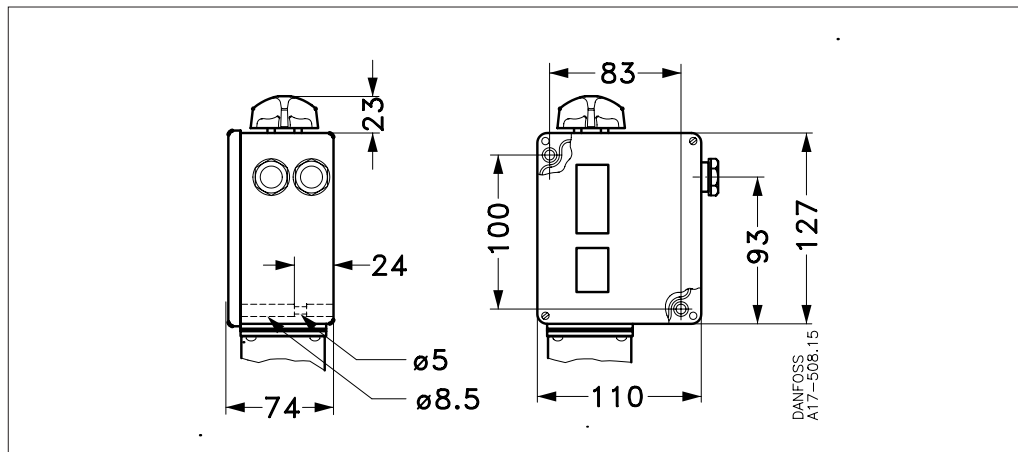

RT 4, RT 11, RT 16L, RT 17, RT 34

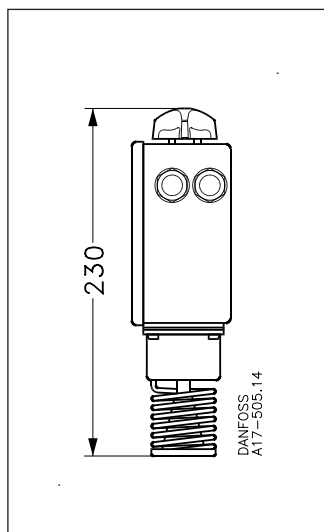

RT thermostat housing

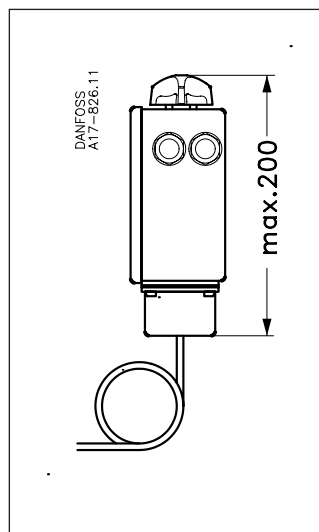

RT 140, RT 140L

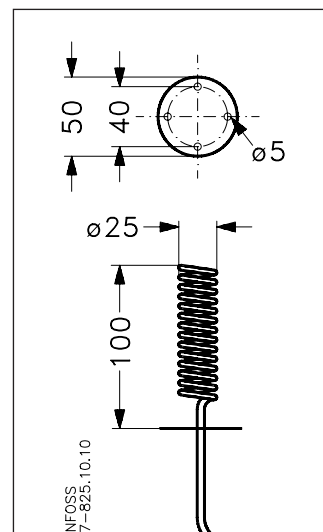

RT 2, RT 3, RT 7, RT 9,
RT 13, RT 101

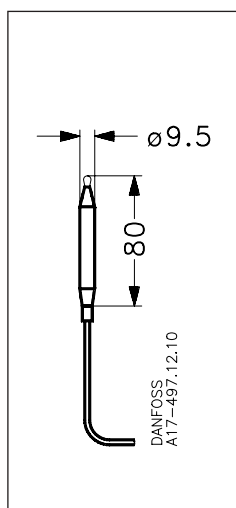

RT 8, RT 8L, RT 14,
RT 14L, RT 15, RT 107,
RT 270

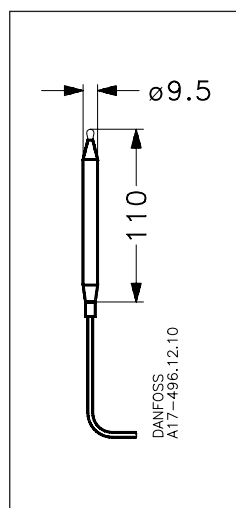

RT 12, RT 23, RT 24

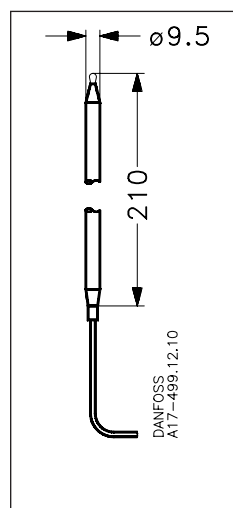

RT 102

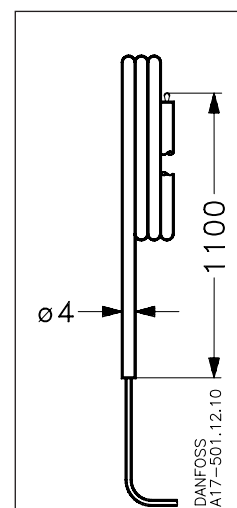

Net weight approx. 1 kg

